



# MAXWELL

Electrotechnische Vereniging

Issue 22.4 | July 2019

## Integration



### **Electrical Sustainable Energy**

The Heart of the Energy Mix

### **Integrated Devices for Neuronal Ultrasound Stimulation**

The way to surgery-free neuro-prosthetics and electroceuticals

### **Interview with Miloš Cvetković**

Learn more about our Teacher of the Year



**Fatma**  
Technologist (Former Trainee)

# We drive the **energy transition**

## **We are looking for you!**

TenneT is a leading European Transmission System Operator active in the Netherlands and Germany. We ensure the reliable and secure electricity supply to 41 million end-users. Our focus is on integrating energy markets and facilitating the transition to a sustainable energy supply. At TenneT you get the opportunity to work in a professional environment where you can develop yourself professionally and personally.

**Empower your career and visit**  
[www.werkenbijtennet.nl](http://www.werkenbijtennet.nl)



# From the Board

Commisioner of Education

Commisioner of External Affairs

*Lotte Zwart*

*Franck Kerkhof*

Dear readers,

Past quarter has been a busy one. For instance, a couple of weeks ago there was the Teacher of the Year election. Students were able to vote for two weeks on their top 3 teachers. Also, they were able to leave positive comments about their favourite teacher. On the 3rd of June the results were announced. For EE this meant that Marjan Popov came in third, Rob Remis came in second and the Electrical Engineering teacher of the year is Milos Cvetkovic. On behalf of the ETV board we once again congratulate Milos with his win! The EEMCS teacher of the year went to the Computer Science teacher Stefan Hugtenburg.

Also, on Monday the 24th of June the EE and SET teacher held an education day. On this day the results of the pre-committee for the new curriculum have presented and they gave the input for the curriculum committee. Next year this committee will be formed and they will overhaul the current curriculum. It is estimated that this new programme will be implemented in the academic year 2021-2022.

Also, on this day the EDIT team (EEMCS Diversity Inclusion Team) presented themselves and thought about some current issues with the present teachers. Although not everyone shared the same opinion on some matters, it was acknowledged that there could be a lot to gain. If you experience problems or if you want to propose solutions, you can email them at [edit-eemcs@tudelft.nl](mailto:edit-eemcs@tudelft.nl).

This concludes not only this educational update, but also my year as a Board member. I hope you've read some of my opening words and maybe even learned a thing or two from them. Next year, Joos Vrijdag will take over as Commissioner of Education. You can reach us with ideas, complaints or just to talk at [education-etv@tudelft.nl](mailto:education-etv@tudelft.nl). Enjoy the summer and good luck with any possible resits!



Dear reader,

In front of you, you have the fourth and thereafter the final edition of the Maxwell of this academic year. The Maxwell Committee has worked extremely hard and they produced four astonishing magazines again. However, everything comes to an ending and so it does for the Maxwell Committee as well as for us as a Board. With this year coming to an ending, it is the perfect time to reflect on the past year, which was an amazing year. We had another great edition of the EEMCS Recruitment Days and we had a study tour to Berlin in which we did not only discover the career opportunities, but also improved our cultural awareness by visiting some amazing sights such as the Berliner Tor. However, having a board year does not only give you the opportunity to get to know career opportunities and have some amazing experiences, it is also the perfect moment to get know a lot of people and integrate with the members of the ETV and other boards as it is (at least for me) always fun to know a lot of people and have very many friends. To conclude with that, I would like to thank everyone I've met and my board in special for this amazing year.



# Colophon

Year 22, edition 4, July 2019

## Editors

Mathijs van Geerenstein  
Sebastian Jordan  
Bob van Nifterik  
Medha Subramanian  
Karen van der Werff  
Stefanie Brackenhoff

## Contributors

S. Aanhane, S. Brackenhoff, J. van Breukelen, D. Cavallo, L. Croes, M. Goddijn, S. Jordan, W. de Laat, J. Lut, M. El Makkaoui, B. van Nifterik, T. Plantfeber, K. Pronk, R. van Schelven, R. Shinde, P. Trimp, M. Spirito, J. van der Weerd, K. van der Werff, M. Zeman

## Advertisements

Page 1 - Tennet  
Page 15 - ASML  
Page 39 - Technolution  
Page 40 - Alliander

## Printing

Quantes, Rijswijk, 1400 copies

## Electrotechnische Vereeniging

Mekelweg 4  
2628 CD Delft  
The Netherlands  
Phone number: +31 15 278 6189  
Email: board-etv@tudelft.nl  
Website: www.etv.tudelft.nl

## 147<sup>th</sup> Board of the ETV

President - Laurens Vergroesen  
Secretary - Philip Groet  
Treasurer - Willem de Laat  
External Affairs - Franck Kerkhof  
Education - Lotte Zwart

## Subscriptions

Non-members can get 4 issues of the Maxwell against an annual contribution of €10,-.

## Change of address

Please send changes in your address to the (e-mail) address above or use the website.

# Editorial

Dear readers,

This is already the last Maxwell edition of this year. I hope you have had as much fun reading it, as we have had making it!

While the theme of this edition is 'Integration', it has been a theme for our committee throughout the entire year. While obtaining the content for the magazine, we have had the opportunity to meet various interesting people and hear many compelling stories. From ambitious students to inspiring teachers, and from the faculty's rich history to its innovative and cutting-edge research - we've heard it all! I believe this process has increased our appreciation for the faculty's people, and I hope the articles have conveyed the same appreciation to you too.

A big thank you to everyone who has contributed throughout the year!

Enjoy this last edition,

*Karen van der Werff*



Dear readers,

Currently you are holding the fourth and last edition of the Maxwell our committee will get to make. Its theme is 'Integration' and personally I believe there could not be a more fitting theme to our final edition. We always try to integrate as many parts of the field of electrical engineering as possible into our pages.

Perhaps even more importantly, however, we have tried to integrate as many parts of the faculty into the Maxwell as possible this year. In this Maxwell, you can enjoy an alumnus special about life after EEMCS, columns from both bachelor's and master's students, articles by the Studieverzameling and, last but not least: an interview with Miloš Cvetković, our teacher of the year.

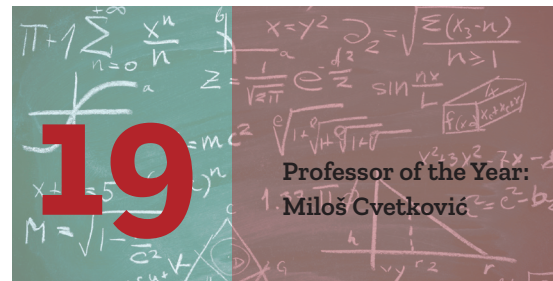
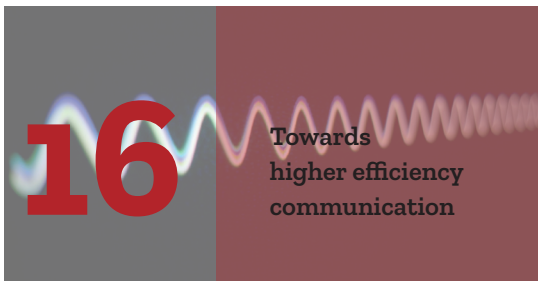
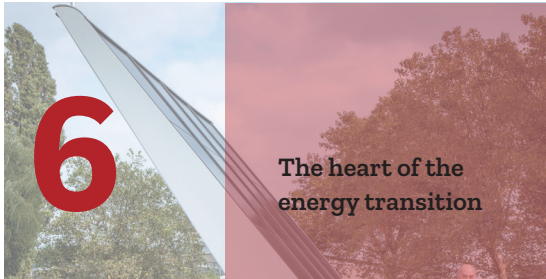
I hope you will enjoy the articles we have brought together in this Maxwell.

Happy reading!

*Stefanie Brackenhoff*



# Index



DreamTeam: Hyperloop	10	32	DIY: Smart fridge scale
An early tone generator	14	34	Activities
Bachelor Column	26	37	Communications of EEMCS
Master column	27	38	Quarterly flyer

# Electrical Sustainable Energy

## The heart of the energy transition

Prof. Dr. Ir. Miroslav Zeman

Prof. Dr. Ir. Miroslav Zeman moved from Czechoslovakia to the Netherlands almost thirty years ago. Since then, he has been working hard to change the way in which useful energy is obtained and used. Currently, he leads the Department of Electrical Sustainable Energy at EEMCS, with an ambitious mission for clean electricity worldwide.

### Differences between Czechoslovakia and the Netherlands

I was born in Czechoslovakia, in the city of Žilina. Today, after the separation of the Czech Republic and Slovakia, Žilina is a city in Slovakia. I have been living in the Netherlands since 1990. The most striking difference between Slovakia and the Netherlands is the landscape. Slovakia is an inland country with high mountains and a lot of forests, while the Netherlands is a geographically low and flat country, neighbouring the North Sea. About 26% of its area is below the sea level and 50% of its land exceeds only one metre above the sea level. This geographical situation makes the Netherlands vulnerable to flooding. That is quite a difference when compared to Slovakia, where the lowest point lies at 94 metres above the sea level.

The Netherlands pays enormous attention to protection against flooding. The Dutch government and many civil-society organizations carefully examine potential threats that can increase the risk of water disaster. One of the most serious threats is global warming that contributes to climate change. There is a consensus in the scientific community that global warming is in a large part caused by human activities resulting in an increase of carbon dioxide (CO<sub>2</sub>) concentration in the atmosphere. This is due to emissions from burning fossil fuels, such as coal, gas or oil, that are widely used in transportation and for generating electricity and heat. At present, fossil fuels account for 94% of the primary energy sources in the Netherlands

and this overwhelming dependence on fossil fuels poses an enormous challenge.

### Air pollution

Another consequence of the massive use of fossil fuels, especially in road transport and electricity generation, is air pollution. You can check the quality of air in the Netherlands yourself by visiting the website [www.luchtmeetnet.nl](http://www.luchtmeetnet.nl). You will find that the air quality is almost never good. According to Air quality in Europe - 2018 report[1], air pollution is a major cause of premature death and lung diseases, and is the single largest environmental health risk in Europe. Estimates of the health impacts attributable to exposure to air pollution indicate that in 2015 it was responsible for about 422 000 premature deaths in Europe and about 12 000 in the Netherlands.

*“You will find that the air quality is almost never good”*

As the report states, air pollution is perceived as the second biggest environmental concern for Europeans after climate change. Since I suffer from asthma, air quality is a particularly intimate subject for me, and I do my best to contribute solving this situation.

It is not only me who wants a change in the way useful energy is obtained and used. This concern is shared by many

in the Netherlands and it brings tangible results. The Agreement on Energy for Sustainable Growth approved by the Dutch government in 2013 and present negotiations on the Agreement on climate pave the way for the transition from the use of fossil fuels towards utilization of renewable energy sources, such as solar and wind energy. Since my whole professional career has been closely related to this energy transition, the Netherlands is a great place to pursue it.

### Solar Energy

I started working at the TU Delft as a researcher in the field of solar cells. Solar cells are devices in which the energy of solar radiation is converted directly into electricity. This electricity-generating technology is called photovoltaic (PV) technology. Actually, it took me some time before I realized that I was busy with something that could profoundly change people's lives. Shaping a world where people can enjoy a better quality of life has become my dream and also a mission: “Imagine all people in the world having access to affordable and clean energy in its most elegant form we use today; electricity. And the primary source of this electricity is the donor of all life on this planet: the Sun”.

At that time, about 15 years ago, solar cells were very expensive and access to affordable solar electricity was a dream for many people. Recently, this situation has changed dramatically. Today, in places with a lot of sunshine, photovoltaic technology delivers the cheapest

electricity in the world. No other technology, whether based on coal-fired or nuclear power stations, can compete in price of generated electricity. For me, it is like a miracle. My dream is step by step becoming true. In 2002, I have installed my first solar system on the roof of my house in Delft and in 2015, I have extended it. It is wonderful to see that more and more Dutch people are embracing this new technology, and that they are buying and installing solar systems for producing their own, cheap electricity.

*“Imagine all people in the world having access to affordable and clean energy in its most elegant form we use today; electricity.”*

In order to promote utilization of solar energy in Slovakia I co-founded a Slovak Renewable Energy agency (SKREA) in 2006. Since that time the agency has helped to install first solar systems in Slovakia and has organized several conferences and demonstration activities in order to inform public about the advantages of using solar energy.

### **The Electrical Sustainable Energy Department and its teams**

At present, I lead the Department of Electrical Sustainable Energy, which is active in research that significantly contributes to the acceleration of the energy transition. In this department, we work on a number of important topics that are related to the future energy system. In the following paragraph, I give three examples:

- We continuously improve solar cells, with respect to their energy conversion efficiency and cost. The PVMD (Photovoltaic Materials and Devices) team fabricated labora-



*Figure 1. Prof. Dr. Ir. Miroslav Zeman.*

tory-scale solar cells based on thin films of silicon with the world-record performance. Since 2001, students of our university have built a series of cars powered only by solar electricity. They call the cars Nuna and compete in the Bridgestone World Solar Challenge in Australia. This is a kind of Formula 1 race for solar-powered electric cars. From nine appearances, our students won the race seven times and twice finished second. A fantastic performance that illustrates a high level of knowledge, practical experience

in different areas of constructing a car, and excellent team work. Throughout this whole period, the PVMD team has facilitated the students with measurements of solar cells and design of modules, which they integrate on the surface of the cars. Since I believe that solar cells will be integrated literally everywhere around us in the future, we design and test multi-functional components that, in addition to electricity generation, fulfil thermal, mechanical, and aesthetical



functions. In this way, we want to contribute to a broader social acceptance for this world-changing technology.

- Another important research topic in the department is energy savings and energy efficiency. In addition to large-scale utilization of renewable energy sources, this topic is an important part of the energy transition towards a low-carbon economy. Electricity delivered from solar energy is direct current (DC) and most new consumer devices, such as electric cars, batteries, mobile phones, computers or LED lamps, operate also on DC electricity. Our electricity grid operates at alternating current (AC) and the DC/AC inverters are used to convert DC electricity into AC and vice versa. In order to avoid losses during the DC/AC conversion, the DCE&S (DC sys-

tem, Energy conversion & Storage) team of the department designs and tests autonomous electricity networks, so called microgrids, that work only with DC electricity. Students of the department constructed DC-operated prototypes for charging of electric cars and bicycles, directly powered by solar electricity. Electric cars are seen as the sustainable future of transportation. However, they are truly sustainable only if the electricity used to charge them comes from renewable energy sources and not from fossil fuels.

- The replacement of fossil fuels with intermittent renewable energy sources and electrification of new areas such as transportation, heating, and industrial processes, requires a new design and infrastructure of electrical energy sys-

tem. The biggest challenge is the integration of new technologies and components for generation and storage of electricity, technologies for information and communication, and models for markets and control into the existing electricity system without compromising the performance of the existing system. The IEPG (Intelligent Electrical Power Grids) team of the department works on stability, protection and cyber-physical security issues of the future system. In order to control the ever faster dynamic phenomena in the whole electricity grid and avoid instabilities in the grid, the IEPG team develops the control room of the future that will help the transmission and distribution system operators in The Netherlands to maintain stability and reliability of the grid.

**Figure 2.** DC-operated prototype for charging bicycles, directly powered by solar electricity. It can be found next to EEMCS.





### The ESP Lab

In order to be the trendsetter in the energy transition, the innovative research programs of the department and multidisciplinary collaboration have to be carried out in a state-of-the-art laboratory. The executive board of the university gave the department a green light to build such a laboratory; Electrical Sustainable Power (ESP) laboratory. The ESP Lab will be completed at the end of 2020. It will become the place where the integration of new technologies and components in the power system will become a reality and where the researchers of the three teams of the department will work together.

The laboratory will have advanced research and test facilities for designing, fabrication, characterization, optimization, and validation of new materials, components, technologies and systems for the future sustainable energy system. Examples are solar cells, power electronic converters, electrical machines, microgrids, smart grids, HVAC and HVDC components, monitoring and diagnostics. In order to demonstrate the relevance of our research to a broader public we aim to build two demonstrators in the ESP Lab; the House of the Future and the Control Room of the Future. The transmission system operator of the Netherlands, TenneT, became the first industrial strategic partner in the ESP Lab in 2018. Mr. Mel Kroon, at that time the CEO of TenneT, explained the reason for joining forces with TU Delft:

“Sustainability, electrification, digitization and storage require a new electricity system with a central role for TenneT. In the ESP Lab, TenneT and the TU Delft as well as other parties can shape the electricity system of the future”.

### The conceptual artwork of science

When I was appointed full professor at TU Delft in 2009, I had to think about my role as a professor. In this respect, art helped me to formulate my mission as a professor. I visited the famous Kröller-Müller museum, where I came

*“The Electrical Sustainable Power (ESP) laboratory will have advanced research and test facilities for designing, fabrication, characterization, optimization, and validation of new materials, components, technologies and systems for the future sustainable energy system.”*

across a modern object by an American artist called Bruce Nauman. Bruce Nauman is considered one of the most most influential contemporary artists in the world. The object I admired, was a text made of neon lamps in the form of a spiral which read: “The true artist helps the world by revealing mystic truths”. I considered the object an excellent example of a conceptual artwork with a clear personal message from the author about the meaning of his activities.

Since that time, I also wanted to give a meaning to my activities by using a sim-

ilarly short but strong statement. When becoming a professor, the formulation of this statement has become even more urgent. What should be my role as a professor? I formulated my conceptual artwork as follows: “The true professor helps the world by sparking the flame of creativity and the spirit of Prometheus”. The spirit of Prometheus, you ask? The reason is that in the logo of TU Delft, there is a sign that represents the flame of the mythical Prometheus. He stole fire from the Greek gods living in Olympus and introduced it to the people.

For me, this act of Prometheus, showing people how to use heat, or in other words thermal energy, marks the true start of the energy transition. My ambition is to inspire students to become Prometheus followers that carry on the energy transition by replacing fossil fuels by solar energy for the benefit of the people all over the world. I and all my colleagues in the department of Electrical Sustainable Energy are happy to welcome students to work together on the successful energy transition and make the world a better place to live in.



[1] Air quality in Europe – 2018 report, EEA Report No. 12/2018

# Alumnus speaking: Life after EEMCS

*Rhythmima Shinde*

**In this special, EEMCS-alumnus Rhythmima Shinde speaks about her life after graduating. With her thesis focusing on rural electrification in India, she was appointed best graduate of the TU Delft. After that, she co-founded the start-up Energy Bazaar and started a PhD at the ETH Zurich. Continue reading to find out more about the various possibilities and challenges that pop up after graduation!**

Being associated to more than one department, life after masters has been well... filled with multiple opportunities, but challenging and yet rewarding in every way possible. So before I dwell deeper into the opportunities, challenges and rewards, a brief about my life before and during EEMCS: I graduated in 2018 from TU Delft with masters in Data Science from EEMCS and masters in Policy Analysis (EPA) from TPM. Before my masters, I did my bachelors in Engineering in India. Growing up in India, I have seen how a lack of basic facilities like electricity or clean water hampered the development of rural and urban slum localities.

This motivated me to start a project on rural development near a village during my bachelors in Mumbai and engage many engineering students to develop technical solutions for these basic issues e.g. access to clean water, better livelihood options, etc. However, during the implementation of these amazingly innovative technical solutions, we realized that implementation in a rural or not-so-developed region remained a challenge because of the lack of coherence of policies, people, industries and technologies.

## **Studying at the TU Delft**

I decided to pursue a masters in EPA or Engineering and Policy Analysis at TU Delft, which is a very unique program tailoring the policy development for

industries with multiple stakeholder clashes. During this program, I realized that policy analysis meant a lot of data-driven modelling. This opened up the whole world of better data models i.e. data-science, for me. For example, I could use them right from Machine Learning and Neural Networks for understanding patterns in census data, to Agent Based and Artificial Intelligence models for understanding the reasons (motivations) of behaviors of different actors in a given environment/ system setting. Thus, I finally took up my master thesis, which entailed my work in two universities (ETH Zurich) and under main supervision of two departments (TPM and EEMCS at TU Delft).

My project was on finding solutions for the major socio-economic and technical barriers in implementation of peer-to-peer electricity trading platforms for rural electrification in India [1]. Thanks to the thesis, I ended up being awarded the best graduate of TU Delft, so all-in-all life until EEMCS ended quite okay after relentless working days, weekends and nights.

## **The opportunities after graduation**

But what happened to all this after my masters? I will first tell you about the bright side of the picture – I got multiple opportunities to continue my work, improve my skill sets and meet many amazing people in the similar sector. The first biggest opportunity that came

up, was with the idea of the Energy Bazaar. Combining a master thesis project of Dirk van den Biggelaar (System Controls, 3ME), Yvo Hunink (Sustainable Energy Technology, EEMCS), and two of my theses, we came up with the idea of working on a startup, Energy Bazaar.

Energy Bazaar [2] is a blockchain and AI-based peer-to-peer energy-trading software platform, which allows trading of electricity from one solar rooftop with excess of energy to another house, which needs energy. Through our master's projects, the idea originated and we created a basic simulation platform as a proof-of-concept with developers from different parts of the world in a blockchain hackathon [3]. Also, through a hackathon at COP23 in Bonn (Climate Change Conference by UNFCCC), we developed another proof-of-concept to integrate this platform with hardware like communication using smart meters [4], with a multidisciplinary team with blockchain, AI, hardware, marketing and front-end specialization.

The next opportunity which came to me personally, in the same time of development of Energy Bazaar, was a PhD opportunity at ETH Zurich. Due to my multidisciplinary experience in policy design, and data modeling from AI-ML to data management, I found a sweet position at Environmental Engineering lab of ETH Zurich. My ongoing PhD project is about developing AI and ML

models to understand the consumption behaviors in urban residential buildings and to suggest policies to building owners (and Swiss economy) to combat their environmental footprints. This work has been an extremely good learning experience for me until now, where I am being put out of my comfort zone every day. On a daily basis, the tasks can be anything or everything between - developing neural network models, understanding how the environmental emissions are calculated for an apple to an air travel, talking to building owners in German, developing schemas for terabytes of data in postgres, working with social scientists and economists, teaching a class or two, supervising a student, or just lying in the grass.

### Facing various challenges

As much as all the above opportunities look like a rosy picture, here is the hard truth – it comes with many tough challenges. The first challenge I faced as the team of Energy Bazaar, was implementing the proof-of-concept solution to real world pilot. After multiple discussions, there were some successful partnerships established in India, but with passing time, they fell off, due to differences in research-industry motives. The implementation has been a challenge at a technical level as well, due to the limitations of storage solution, lack of accessibility to reliable telecommunication networks in rural India and multiple infrastructural issues. Also, with all of us doing Energy Bazaar as a part time stint from three different countries, the responsibilities have been difficult to manage. However, having said this, the main challenge I think which remains

is the “newness” of the blockchain technology and peer-to-peer energy regulation market. At both the technical and the policy front, Energy Bazaar is a very innovative challenge and opportunity to the current infrastructure and policies of not just India and developing countries, but also many developed countries. Many solutions in the energy p2p market are coming up, but all of them remain a pilot, because of these incompatibility issues of old electricity market regulations and infrastructures.

Coming to the challenges as a PhD student, I can definitely say for many of my colleagues doing a PhD, life of a PhD student is hard. At times, it can be extremely rewarding, getting multiple results on some fine sunny day, while at the same time, it can be extremely discouraging when running the same model for months still gives stupid results. But the toughest challenge in my PhD has been the multidisciplinary nature of it. As much as I see it as an opportunity, I know it is a tough job of an integrator like me to merge the fields of social science, environmental engineering, economics and energy into one data model.

### The rewarding experiences

Now obviously you are expecting me to finish this all on a good note – and yes, there is a lot of good stuff or rewarding experiences to share. As much real and hard as it gets on a daily basis (because that is what we sign up for after doing a tough masters or bachelors), I truly enjoyed this journey of my life after EEMCS. I learn so many things every day as a co-founder of the Energy Bazaar or as an ETH Zurich PhD student. Right

from management skills in the entrepreneurship department, to distributed computing in Computer Science department, I can take any course or put anything on real world implementation – which makes my learning go well in both breadth and depth. I get to meet many experts in different fields and get feedbacks for my work, right from policy makers in Vancouver in a ministerial conference [5] to experts in industrial ecology in international conference in Berlin (all in the same month!).

I get to have a multicultural and highly innovative environment every day, where I not only work in flexible hours and learn everything from personality development skills to languages, but also participate in sports and spend time in the beautiful Swiss nature. The biggest professional reward has been to develop the ability to be agile and adapt my work to the situations and environment. For example, we have been adapting the idea of Energy Bazaar to the urban developed parts of the world, especially in the building sector. For the sake of the pilot, it becomes easier to do under our direct supervision (bringing in more partnerships as well) here in Europe, and helps integrate my PhD learnings quite directly into the startup.

I would like to conclude with this small example of my own experience, that life after EEMCS can be extremely opportunistic and full of challenges, but yet extremely rewarding. So, keep doing what you are doing, even if it gets a bit rough – life is definitely greener on the other side!



- [1] For details, please refer to the TU Delft repository or my ResearchGate profile
- [2] Details on our website of Energy Bazaar: [www.energybazaar.org](http://www.energybazaar.org)
- [3] Medium Article by Yvo Hunink on 'blockchain for social impact: Energy bazaar experience' <https://medium.com/energy-bazaar/blockchain-for-social-good-hackathon-the-energy-bazaar-experience-dea0cdc31393>
- [4] Medium article by me on COP23 hackathon experience: <https://medium.com/energy-bazaar/how-can-programming-as-complementary-skill-to-policy-analysis-help-develop-climate-change-solutions-6589774186ca>
- [5] <https://www.rhythima-shinde.com/event-blog/2019/5/30/verdicts-on-bottom-up-electrification-market-innovations-meeting-regulations-takeaways-from-cem-mi>

# Delft Hyperloop

Laura Croes



**In the future people will travel further and more often. Airlines will not be able to keep up with these demands and airplanes will not have gotten much more sustainable. So, what solutions do we have? People need something that will go fast, which currently is the airplane, but also something that is comfortable and sustainable. The train would satisfy the latter, but it is not very fast and so we need another solution. However, there haven't been any more real breakthroughs since the invention of the airplane; expect for the Hyperloop.**

## What is the Hyperloop

The Hyperloop was documented first by Elon Musk. He wrote an alpha paper on the Hyperloop in 2013. He came up with the idea, as the government was planning to build the California High-Speed Rail. This railway was going to be built in hope to reduce the daily traffic jams in California. However, this railway is expensive and, in the end, would save the passenger a lot of time or money. A Hyperloop would be much faster, cheaper and sustainable. If you want to read the specifics, the Alpha White Paper can be found online on SpaceX's website.

So, what is the Hyperloop? Well, in its most basic form the Hyperloop is a train-like vehicle that travels in a low-pressure tube, reducing its drag, and uses a magnetic field to levitate, reducing its friction. This allows the

Hyperloop pods to travel at speeds of around 1000 km/h. This is even faster than an airplane. With such a high speed, ease of use and it being an electric system (allowing it to be sustainable when energy is harvested from sustainable resource), it satisfies all the criteria needed to solve the increasing demand in transportation in the future.

## The competition

As the Hyperloop is still in development and a lot of research is still to be done, Elon Musk created the SpaceX Hyperloop Pod Competition. This is a student competition of which the criteria to win changed slightly over the years. The very first competition was in January of 2017. For this competition the main focus was scalability. The very first Delft Hyperloop team competed in this competition and won first place. Their

pod was a scaled down version of a Hyperloop Pod as they had designed it. It had Halbach arrays which were used to levitate the pod once reaching a higher speed. The propulsion of the vehicle was done by a launcher which was provided by SpaceX. As the second competition was only 6 months after the first one, the second team of Delft Hyperloop competed again in the third competition. This took place in the summer of 2018. For this competition, the main criterium was top speed. This top speed was to be reached on the track inside the 1 mile long tube located at SpaceX in Hawthorne California. Delft Hyperloop placed second and first prize went to the Germans, WARR, with a top speed of 467 km/h.

## My year at Delft Hyperloop

Now this is where I come in. I, Laura

Croes, am currently Lead Powertrain of the third Hyperloop team. We will compete in the fourth SpaceX Hyperloop Pod Competition, which will take place in California this summer. The requirements are, once again, to reach the top speed on the track inside the vacuum tube of 1 mile. In the beginning of the year hundreds of student teams had signed up. In October 50 teams had made it through the first round with their preliminary design. By February only twenty teams were left with their detailed design. These twenty teams, including Delft Hyperloop, will be traveling with their Pod to California this summer. Here we will go through one week of testing. We will have to go through hundreds of tests and the teams that pass the most tests will get to run in the tube. This will be the only run where you can actually test your vehicle to its top performance. Everything has to be perfect.

Currently, I am in between my third and my second year of my bachelor in Electrical Engineering. I decided to take this 'gap year' as I wanted more practical experience. I wanted to actually feel

like an engineer who knows how to design, test and build a system powerful enough to power a Pod to travel with these high speeds. As Lead Powertrain I am responsible, together with my department members, to design, build and test the Powertrain. This consists of motor controllers, batteries, all the safety electronics like the battery management system and, of course, all interfaces with all other departments.

In order to reach such high speeds in such a short distance, the key is to have the highest possible power to weight ratio. This means stripping down all casings of all electronics, searching endlessly to find the lightest version of everything you use as even just 1kg can make a few kilometers per hour difference already. One of areas where we are winning the highest power to weight ratio with is with our batteries.

### The Batteries

In the beginning of the year I researched hundreds of cells and ordered six different types of lithium polymer batteries. I then proceeded to test them all and picked the very best one. Of this cell

type, we ordered over a thousand and then production started. All of these cells were produced into larger battery modules. We laser welded the tabs of the cells to copper plates, stripping the batteries down to their most basic form.

Here comes the tricky part. The Pod will be in low pressure. Which means our batteries have to either be compatible with this lower pressure, or be placed in pressure vessel. NASA, for example, uses pressure vessels for all their batteries and the previous team had also used one. However, using one would add a lot of mass, greatly reducing our pow-

*“So, we were going to take the risk and test it.”*

er to weight ratio. So, we were going to take the risk and test it. Mind you that lithium polymer batteries puff when discharged (this effect is increased in a lower pressure) and are explosive if damaged. This was a big risk, but worth the reward. We started by performing single cell discharge tests in-house. We



**Figure 1.** Testing the powertrain

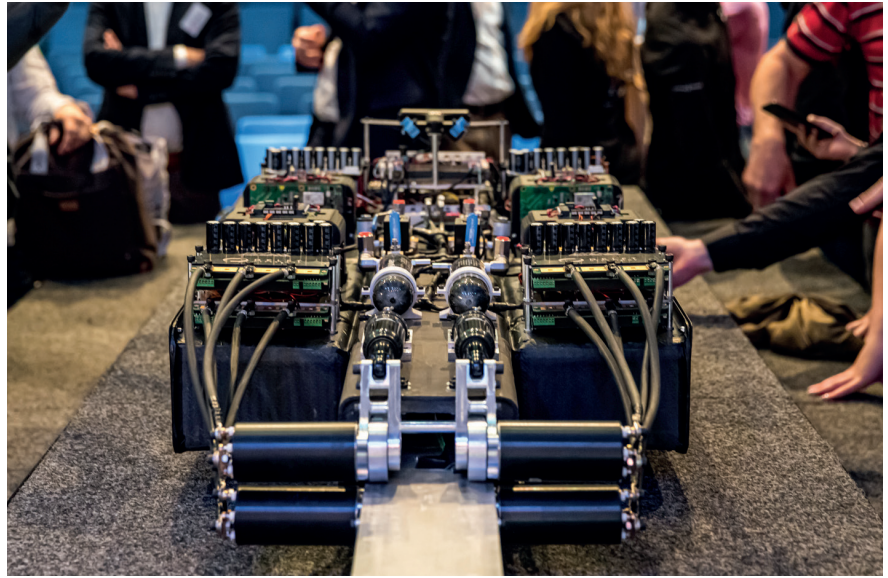


used a large vacuum pan and homemade load to discharge the cells in lower pressure. All went well and so we proceeded with the final goal to load test a battery module in this lower pressure. It was only until the first week of June that a few people from the team traveled to the UK. Here we finally found a company willing to help us do this test. We did this with success a saving probably over 10 kg.

**What's next?**

On the 21st of July, the competition day will be and the week before that all the tests will be performed at SpaceX. With our custom high power batteries, optimized for the vehicle for a short run of 1km, I believe we have a good chance of winning this competition and far surpassing this speed record of 467 km/h.

If you want to follow the competition, you can find Delft Hyperloop on most



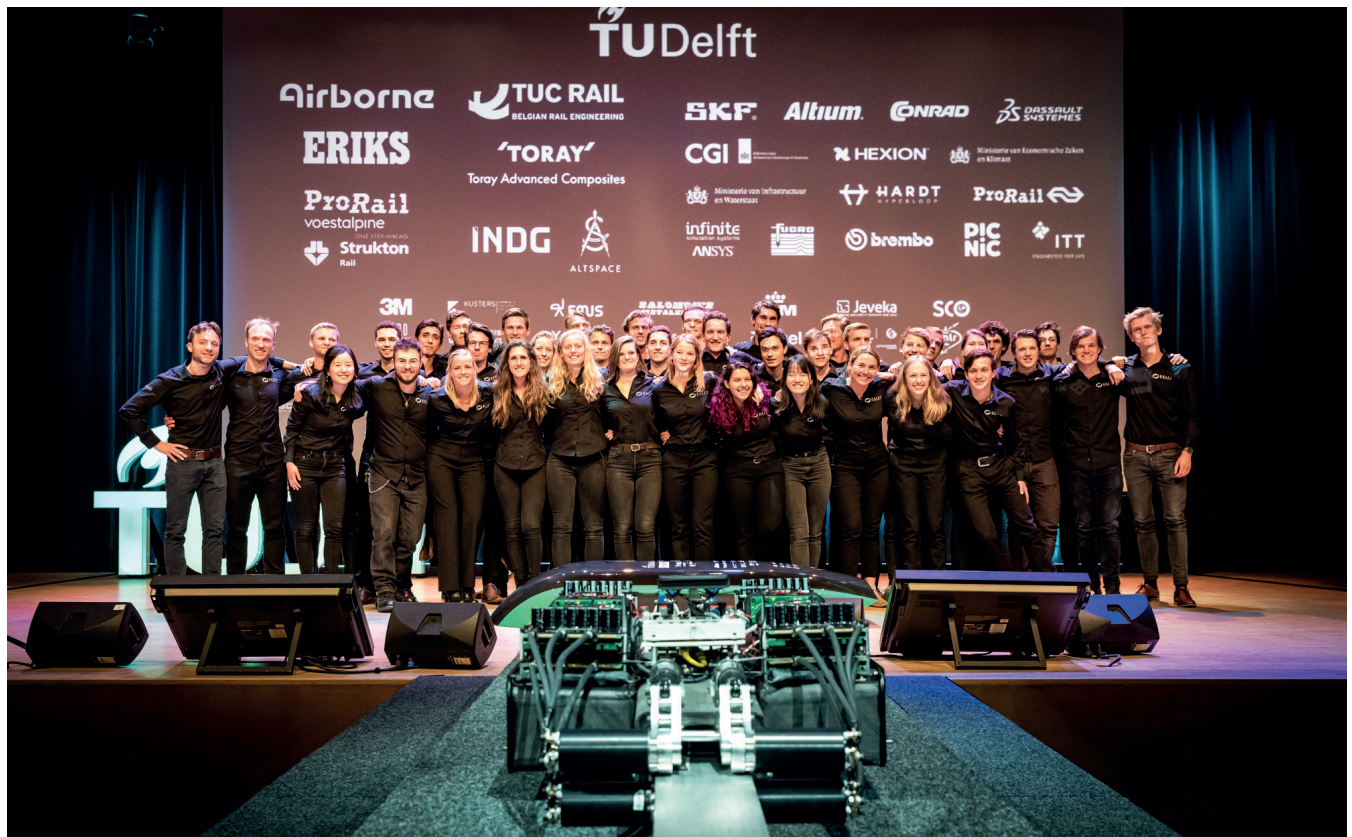
*Figure 3. The internals of the ATLAS 02 at the reveal event.*

social media platforms and if you want to be up to date with the development of the Hyperloop, you should check out our website [www.hyperloopconnected.com](http://www.hyperloopconnected.com). This is a website where articles

on research and designs for the future Hyperloop are published by Hyperloop teams as well as companies which allows you to follow the latest development on the Hyperloop.

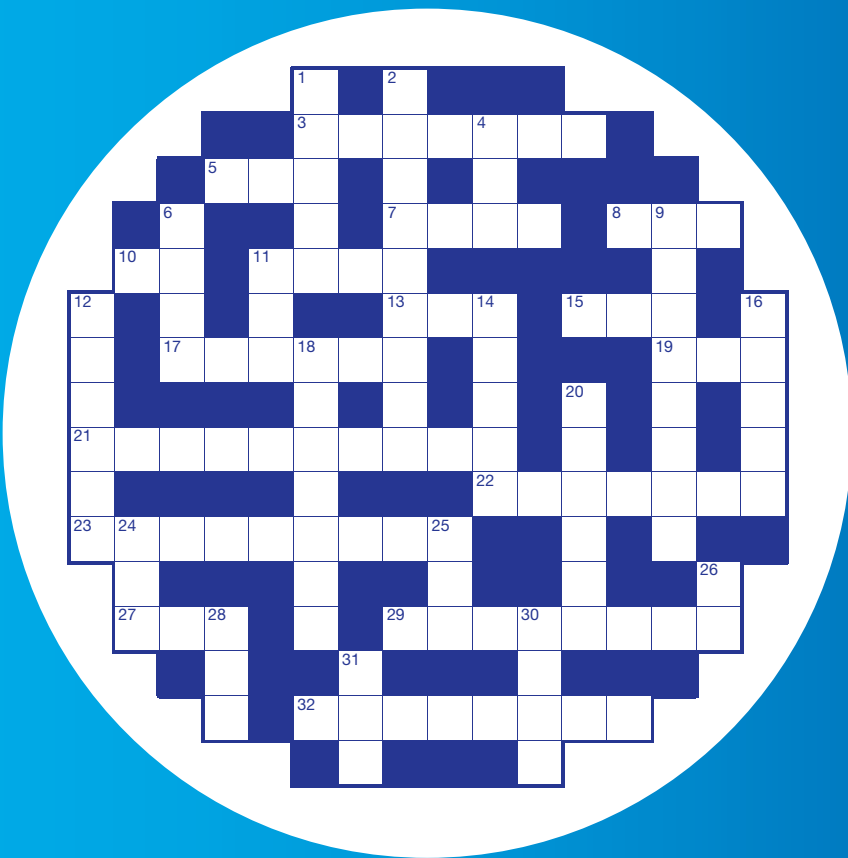


*Figure 2. The team that worked on the ATLAS 02 Pod at the reveal event in June 2019.*



# Puzzle

## to win a Bluetooth speaker!



7	5	4	31	1	6	22	12	20	15	2
---	---	---	----	---	---	----	----	----	----	---

### Across

3. Second profession of the inventor of Morse code
5. Frozen water
7. Component considered to be ASML's heart of the DUV system
8. State of the ... technology
10. Japanese board game
11. Starting material for wafer production
13. Carpenter's tool
15. Chemical elements: Hydrogen + Iodine element + Sulfur
17. Transistor layout
19. Environment friendly
21. First person to win two Nobel prizes for Science
22. Part in ASML system that contains the customer's pattern for chip production
23. Location of ASML's headquarters
27. One of the partners in the 'Metropoolregio Brainport Eindhoven' sponsorship
29. Famous physicist who became a guitarist
32. Decade in which ASML was founded

### Down

1. Type of web browser
2. ASML system to measure on-product overlay
4. Metal used in ASML's EUV light source
6. One of the two sports that has been played on the moon
9. Department that conceives ASML's future technologies
11. Star at the center of our solar system
12. Science fiction writer that invented the three laws of robotics
14. Chips are cut from a ...
16. The Law driving the semiconductor industry
18. Production facility to manufacture a complete ASML system
20. Program language developed in the Netherlands
24. ASML's latest lithography technology
25. Near-infrared
26. Internet country domain for Malaysia
28. Laboratory
30. ASML's biggest market
31. Device that makes you able to interact with a computer

Submit the correct answer by November 30 by e-mailing it to [campuspromotion@asml.com](mailto:campuspromotion@asml.com)  
 Out of the correct answers we will randomly select one winner to win a Bluetooth speaker.  
 The results are not open for discussion.



Curious to learn about our opportunities for students?  
 Visit [www.asml.com/students](http://www.asml.com/students)

# Towards higher efficiency communication with integrated power combiners

*Ir. Ralph van Schelven, Dr. Marco Spirito and Dr. Daniele Cavallo*

The next generation of wireless communication has been a popular topic in electrical engineering for a long time, and in the near future it will be reality. Probably, the main difference we, as consumers, will notice is the increased speed of our smartphone and tablet internet connections. However, beneath the surface many things will be radically different. The increased internet speed will be possible because of a wider bandwidth, which in turn is realized by moving to a higher operating frequency. Also, because of the expected increase in connected devices, the network has to be more efficient in order for the power consumption to stay within reason. This is where the WhALE project (WAtt LLevel transmitters at mm-waves) comes into play.

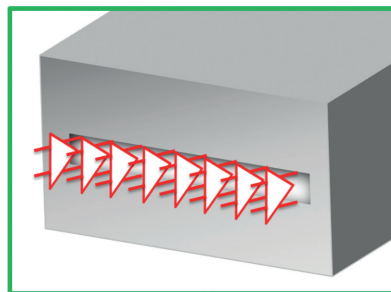
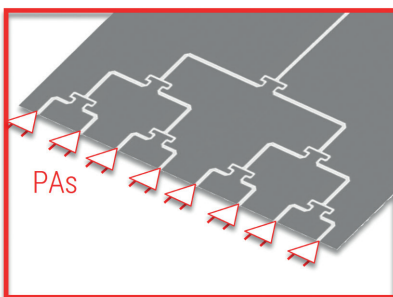
Future wireless networks will connect not just people, but all things: e.g. self-driving cars will communicate through the network to avoid accidents and traffic jams; doctors will monitor health indicators of their patients remotely to provide improved delivery of healthcare. This global connectivity will generate a huge wireless data traffic, forcing the wireless industry to move to its fifth generation (5G) of cellular technology and to find new techniques to offer unprecedented speeds in wireless communications.

From the Shannon-Hartley theorem, we know that the channel capacity of a wireless connection is proportional to the frequency bandwidth of operation. In other words, increased bandwidth means that more information can be sent through the channel, resulting in faster data transfers in a wireless link. The key solution of the 5G network to achieve broader bandwidths is to shift the operation to higher frequencies, especially to the millimetre-wave (mm-wave) spectrum (30-300 GHz), that can provide multi-Gigabit per second (Gbps) data links. These frequencies are much

higher than the current operational bands of the 4G network, which do not exceed 6 GHz. Moving to mm-wave frequency bands comes at the cost of increased complexity of the radio frequency front-ends in wireless terminals and will introduce a number of challenges in the design of the network components.

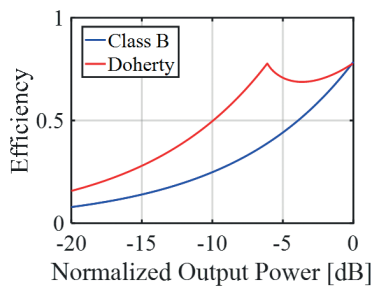
One of the most challenging blocks to be realized at mm-wave frequencies is the power amplifier. This building block needs to provide sufficient output power over the selected band to reliably satisfy the application requirements, and in view of the ubiquitous nature of 5G, it must provide this function in an energy efficient way.

The WhALE project targets system integration, employing complementary expertise in the field of electromagnetics and integrated circuit design to develop the next generation of mm-wave transmitters. These systems will be integrated into smart packages to deliver, through low-loss, broadband interfaces and/or integrated radiating elements, watt-level signals in selected frequency



**Figure 1.** Commonly used Wilkinson combiner and the proposed waveguide combiner.





**Figure 2.** Efficiency curves of a normal class B PA and a Doherty combiner.

bands efficiently while supporting the high data rate schemes of 5G communication.

### Waveguide power combiner

To increase the output power of mm-wave transmitters, one logical approach is to combine the output signals of multiple power amplifiers (PAs) into a single output.

*“One of the most challenging blocks to be realized at mm-wave frequencies is the power amplifier.”*

The concept of combining multiple signals into one to increase the power of the output signal is not a new thing. A commonly used example of a power combiner is the Wilkinson combiner as can be observed in figure 1. It can be clearly seen that by increasing the number of PAs, the size of the combiner and the length of the paths travelled by the different signals increase as well. This increased path length corresponds to an increase in losses.

To overcome this problem we propose to use a different type of structure: a waveguide combiner. An example of such a

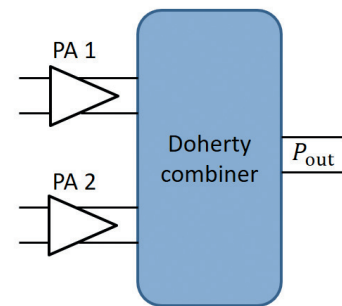
structure is also shown in figure 1. The main advantage of this type of structure over the Wilkinson combiner, is that we can add multiple feeding points to a waveguide, without increasing the size of the combiner and the associated losses. The different PAs are coupled to the waveguide using slots etched in the waveguide wall. Besides the compactness and the independence of the losses from the number of feeds, another advantage is the possibility to combine any number of PAs, whereas the Wilkinson power combiner is typically limited to powers of 2 elements (2,4,8,...).

### Doherty combiner

In order to use a signal to carry information, the signal is typically modulated both in amplitude and phase. To follow the amplitude variation of the signal, the output power of the transmitter needs to vary as well and can often be significantly lower than the maximum power it can send. Therefore, the ampli-

fiers need to operate most of the time at power levels lower than the maximum.

The main difficulty in achieving this, is that a PA on its own operates with the highest efficiency only for maximum output power. The typical efficiency curve of a class B PA is shown in figure 2 as a function of the output power. One way to improve the efficiency is to have multiple PAs work together in a smart way. This can be achieved by implementing a so-called Doherty power combiner. This structure combines multiple PAs, as shown in figure 3, with the goal of maximizing the effi-



**Figure 3.** The power from multiple PAs is combined using a Doherty combining scheme.

ciency by selectively turning the PAs on and off. The operation can be divided in multiple modes, corresponding to the number of connected PAs. For low output powers, only one of the two PAs, the main source, is active to reach an efficiency peak at a certain fraction of the power range. In the second mode, also the second PA (peaking source) is activated. The two PAs generate different amplitudes, to maintain high efficiency up to the maximum output power level. As an example, a typical efficiency curve of a Doherty power combiner is shown in figure 2, where two distinctive peaks can be observed, one at the maximum output level and the other at around -6 dB normalized output power.

### Towards integration of a waveguide Doherty combiner

The Doherty combiner combination scheme is typically implemented on a chip on which the PAs are located. A quarter-wave transmission line connects the two PAs to achieve the desired results. Because of the small dimensions of the transmission line on-chip, high dissipation losses occur. To avoid this issue, we propose to use the above mentioned waveguide combiner to include the Doherty scheme. The final configuration will become the one in figure 4, where multiple slots excite the waveguide. Each slot is connected to a

►

*“This results in an integrated transmitting system comprising of the electronics and the antenna in a single compact module.”*

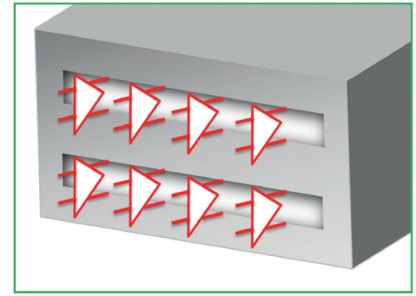
single - or a set of - PAs. All the feeds in oneslot act together as the main source, and all the feeds of the second slot act as the peaking source.

The waveguide can be then connected on the other end to an antenna to radiate the power to free space. Possible radiators can be horn antennas, realized by flaring the open end of the wave-

guide, or slotted waveguide structures. This results in an integrated transmitting system comprising of the electronics and the antenna in a single compact module.

#### **Future steps**

In the Terahertz Sensing Group we are currently working on a printed circuit board implementation of the waveguide. This will allow for an efficient integration of the on-chip electronics with the waveguide. A prototype is under development, aiming at demonstrating the effectiveness of the discussed power combination schemes to achieve unprecedented levels of output power in the mm-wave frequency range.



**Figure 4.** Proposed waveguide Doherty combiner.

This research is part of the 'Advanced 5G Solutions' NXP-TTW partnership. It is financed by the Netherlands Organization for Scientific Research (NWO) with project number 15591.



# Professor of the Quarter

Miloš Cvetković

*Stefanie Brackenhoff  
Medha Subramanian*

Every quarter, the Maxwell Committee interviews a Professor of the Quarter. Who better to ask for this edition than our very own Teacher of the Year: Miloš Cvetković?

Miloš Cvetković is an Assistant Professor who works on the integration of renewable energy solutions, where he models control and engineering processes. Additionally, he teaches the bachelor's course Sustainable Energy Supply and the master's course Co-simulation of Energy Systems. We interviewed him about himself, his teaching and what he thinks a good engineer should be.

## What is it like becoming teacher of the year?

Awesome! It was especially great when I got the cup. I looked at the names on it and some of the guys who won it before me are really good and my senior as well. I felt really proud, because it is hard to judge for myself how I do. I have not seen myself teach, nor have I looked at any of the recordings on Collegerama. I trust the students, and their judgement.

## What are the things you focus on in your teaching?

I try to get as many people involved as possible. There is a difference between teaching a course for bachelor's students and a course for master's stu-

dents. The master's students that come here really want to learn and to listen. In that case, you need to find a way to explain concepts better and make them easier to understand, so students can learn quicker. I like to visualize things when teaching. For my course 'Co-Simulation of Energy Systems' I gave the students teabags, which they had to exchange with one another. That was because after I taught the lecture before, everyone was confused and no-one knew that I was talking about. So I realized that I could talk about this process forever without achieving anything and I needed to find another way to show how it worked.

With bachelor's students it is not like that at all. You need to focus more on finding ways to retain their attention, to keep the students in the moment and in the classroom. Then you just fill the blanks in between with some knowledge. There are different ways to keep them listening. For example, I have a lot of screenshots from 'The Simpsons' and other cartoons randomly spaced throughout the presentation. I also try to ask questions, in order to try to engage the classroom. Additionally, when you pause while you are speaking, it has a big effect. Suddenly everyone is paying attention, even though I am quiet.



### What is the main difference between the TU Delft and the other places you have worked at?

Students are much more prepared to step into the real world after their studies here than in other places. I taught “EPO-1: the booming bass” for two years, which is the first project course that bachelor’s students see. It is amazing what kind of things the students get to do in those first months. They get to code in Matlab, to build things in hardware and to write the software around it. It takes other universities much longer to get to that point.

If you focus on the application, you realize that there is not enough time for us to teach all the theory around it. We just teach the practical applications. It reduces of overhead for the students.

It is a bit scary at the same time, because the students suddenly need to do a lot of new things at the same time. It can be a bit overwhelming during the first two quarters. After they push through that, it becomes amazing. What I like about EPO-1 is that you are not only teaching the content. You are also mentoring the students and getting more involved with them. I did not expect that to be a part of my job description. At first I did not know what to tell them, but later on I really enjoyed it. You can see that what you do makes a change. What you say and do has big impact on the confidence level of students and their faith in themselves.

*“What happens if the Earth warms up a little is a big unknown.”*

### What would you research or invent if there were no constraints?

I would stop the CO<sub>2</sub> emissions. We are warming up the planet. There are people who are trying to stop that and there are people who are saying it is not happening or it does not matter. I think we do not quite know what is going to

happen. We do know that if we stop CO<sub>2</sub> emissions and change our attitude towards energy we can save our way of living. What happens if the Earth warms up a little is a big unknown. Lately, I have started to hear people talk about adapting to climate change rather than stopping it. I am not sure whether I like that attitude. If we accept we are going to warm up the planet we have an excuse to say: “Well, we already warmed it up a little bit, so we are just going to continue doing that until all the carbon fuels are gone.”

*“We are often trying to make a technology better without comprehending how it fits into the bigger picture.”*

### What do you enjoy in your research the most?

I work on co-simulations. That is the combination of several simulators, in order to build bigger and better simulations. If you take an electrical grid simulation and heat grid simulation and combine them, you get an entire integrated energy system. I like that it is very collaborative. There is no one person who knows everything, but everyone knows their own bubble. When you try to put everything together, you are not just putting the simulations together, you are also putting people together. They start to cooperate because they have a base for it and something they can all participate in. A lot of our inefficiencies in energy stem from a lack of collaboration and a division of responsibility where everyone only handles their own field. We can do better if we talk to each other and do things together. What I am hoping for is to build a tool or a platform where everyone can come together and figure out solutions for a better energy system.

Many problems come from a lack of integration. You can find a lot of examples that intersect domains. A lot of research is invested into combining fields now, rather than doing things independent-

ly. Funds now also call for interdisciplinary projects. They even extend this to outside technology alone, by asking for someone from social sciences to join. That is also important, because you will not achieve your goals with just a technology. You need to enter it into society. We know that the policy regulatory system is slow compared to the engineering system. Politicians have to see how society will react to new technology and make decisions based on that. At the same time, they should be stimulating the change towards a better world.

If you want your technology to make a difference, you need to start small with groups of people, and then slowly make them familiar with concepts. Ideally, you bring in a few people and they become ambassadors for what you are doing. You need to get a few people to do co-simulation, they tell a few others and suddenly it is the next big thing.

### What do you think is the most important skill for an Electrical Engineering student to develop?

The structure of the bachelors is such that we are creating engineers. The people who design the bachelor’s studies really thought about that. They thought about what engineering is, what it should be and what kind of skills you need to have. I think they did a really good job. A lot of additional theory is stripped from the curriculum, but there is enough left to support practice. What I am missing a bit, however, is that we as a technical university are often focused on developing a technology and teaching students to develop technologies without thinking about the impact of what we are doing enough. We often push out a technology and create problems with it. Then we create another technology to solve those problems. We

are often trying to make a technology better without comprehending how it fits into the bigger picture.

Sometimes you have an idea, but there is a big gap between the idea on the one hand and the technology on the other. There are a lot of questions we do not talk about, which are very important. What is the adoption path of the technology? Who will pick it up? Who will bring it to the market? Is it affordable enough for others to buy it? Will it be enough to create a business around and spread the technology? You can do a lot with your technology over here, but if it does not get over there that does not matter.

**If you were to give one piece of advice to students what would it be?**

For bachelor's students: Hang in there! I know your pains. I know that some of you come to my class and are not interested in energy, because you want to do something else. You need to do it as a part of the curriculum. I think it is very important to be exposed to all of this, but it is not easy to appreciate that at that point in your studies. That is fine. Push through it and one day you will see the value.

For master's students: Have a plan at the beginning. There is a lot of freedom and the University is so big, that there are a lot of resources around. If you are doing solar and you want to research machine learning besides it, there might be three or four courses running on machine learning. You need to know where you want to be at the end of your master's and what kind of skills you want to have. Then you can take courses outside of the packages that we are creating. There is a lot of value in preparing yourself for your next steps. Otherwise, you are pushed around by the currents, but there is no guarantee that you end up where you want to be. So define early on where you want to be, and then take the decisions that take you there.



# Study Collection

## A pre-amplifier for use with electronic voltmeters and oscilloscopes

*Kees Pronk, Piet Trimp*

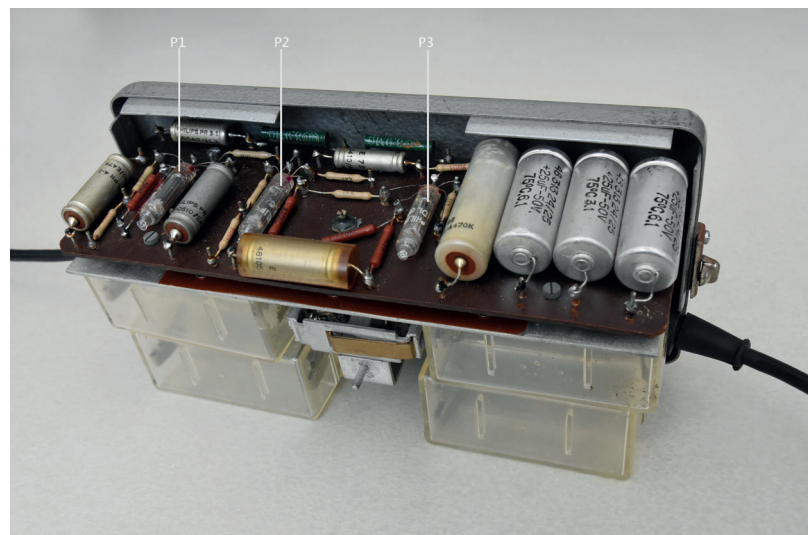
Around 1953 Philips developed a pre-amplifier to increase the sensitivity and input impedance of electronic voltmeters and oscilloscopes. Although the sensitivity of such measuring equipment in those days was already quite high, measurement applications arose where more sensitivity was needed. The Philips GM 4574 to be described here has been developed to have an input impedance of  $5\text{ M}\Omega$  and a gain of  $100\times$  for AC voltages. This article is an adaptation of an article by F.G. Peuscher and J. van Holthoon published in Philips Technical Review in December 1953 (Ref 1). The amplifier (type GM 4574), available in the Study Collection of EWI, is depicted in figure 1 and forms the subject of this contribution.

### General description

In the design of this amplifier, the principal objective was to produce a small unit that would not occupy more space than strictly necessary on a work bench on which room has also to be found for equipment under test and numerous measuring instruments. For this reason, sub-miniature vacuum tubes of the kind originally designed for hearing-aids (Ref. 2) were decided upon, these being operated from dry batteries. The need for a mains transformer, rectifier tube and smoothing equipment is thus dispensed with. Only a small amount of power is consumed by the filament circuits of these sub-miniature tubes, and therefore only small batteries are required. There is another advantage in the use of batteries: the voltage surges invariably occurring in mains voltages,



**Figure 1.** Amplifier GM 4574, giving an amplification of  $100\times$ .



**Figure 2.** Interior of the GM 4574. P1, P2 and P3 are the DL 67 miniature tubes. The four boxes are the battery compartments.

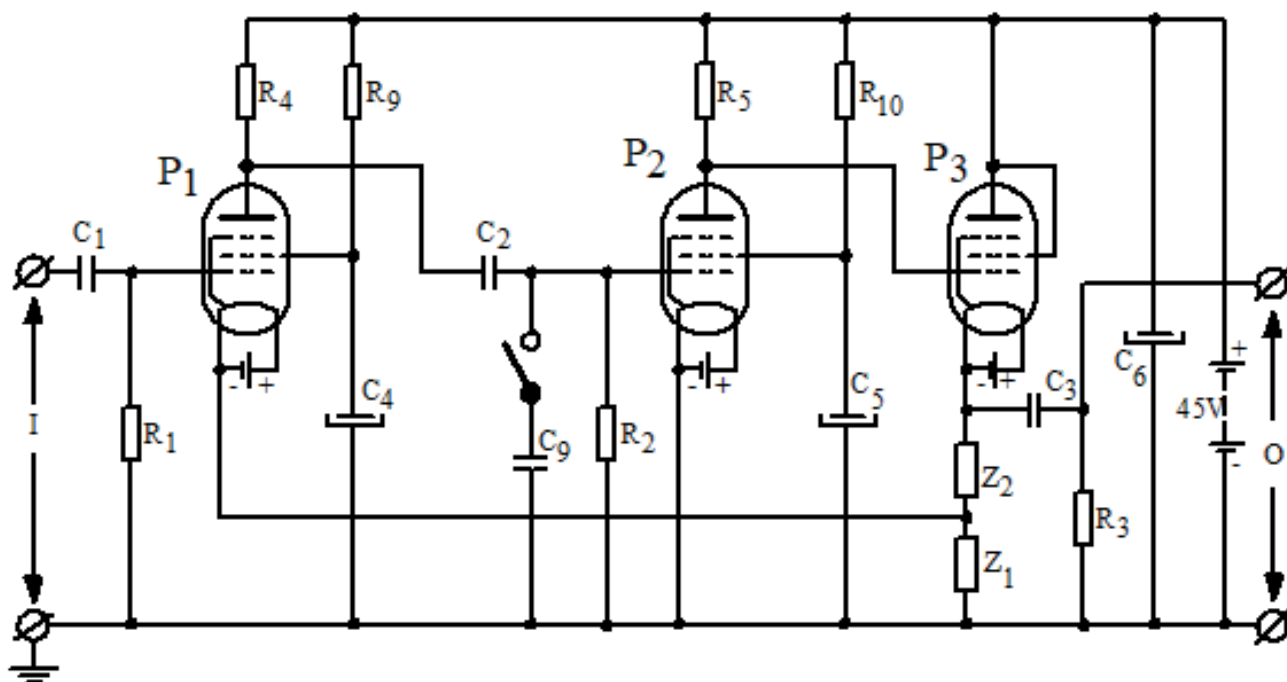
as well as ripple voltages, are completely avoided. This is very important from the point of view of the purpose for which the amplifier is intended, since the input voltages concerned are often very small, viz. of the order of  $0.1\text{ mV}$ .

At the same time, batteries are not without their disadvantages; they tend to produce substances which would set up corrosion or endanger the insulation. In the present amplifier this difficulty has been overcome by housing the batteries in insulated boxes (figure 2) which entirely prevent contamination of the amplifier, and which can be quite easily removed and rinsed in water if necessary.

In order to ensure that the amplification shall remain as constant as possible,

this being of course an essential feature where measurements are concerned, considerable negative feed-back is employed. This is particularly desirable because the slope of the tubes varies fairly widely as a result of the gradual drop in the battery voltages. The 'slope' of the tube is defined as  $i_a/v_g$  ( $\Delta$ -anode current /  $\Delta$ -voltage on the steering grid; expressed in  $\text{mA/V}$ ). This slope is also known under the names transconductance and mutual conductance (see ref. 5).

For an overall amplification of  $100\times$ , the gain that would be obtained without negative feed-back (open loop gain) must accordingly be much more than  $100\times$ . Two stages in cascade are provided, each giving an amplification of



**Figure 3.** Circuit diagram of the amplifier. I = input, O = output

about 63 x, and both stages thus give an open loop gain of 4,000 x. These stages precede a third, cathode-follower circuit, the purpose of which is to keep the output impedance low (less than 5000 Ω), so that the amplification shall be independent of the (high) input impedance of the equipment connected to the output terminal of the GM 4574. The amplification obtained from this third stage is slightly less than unity.

### The circuit

The schematic circuit is shown in figure 3. The three tubes are pentodes, type DL 67. For more information about pentodes, please see ref. 3. As the cathodes are not interconnected in this circuit, each filament (current 13 mA) is fed from its own battery (1.5 V). The battery boxes mentioned above, guarantee adequate insulation between the batteries themselves and with respect to earth. Since the DL 67 uses a directly heated cathode, the cathodes cannot be connected and should be heated from individual batteries (see also ref. 4).

The DL 67 is designed to give sufficient anode current even on low supply volt-

ages (max. 45 V), this being ensured by incorporating in it a screen grid of closely spaced wires. A detailed picture showing how the DL67 has been soldered directly into the circuit is given in figure 4.

The mutual conductance of the screen grid is accordingly very high, which means that variations in screen voltage have a pronounced effect on the working point of the tube. In order to prevent the working point from drifting too much as a result of diminishing voltage from the anode battery, the screen grids of the first and second tubes are fed through high resistances (the third tube is connected as a triode). When the battery voltage drops, the screen current also drops slightly and the voltage loss in the feedback resistor is reduced, thus partly compensating the drop in the battery voltage. Consequently, the screen grid current, and hence also the anode current, are much less dependent on the battery voltage than if the screens were connected direct to a tapping on the battery. Differences in the mutual conductance of the screen between one tube and another are thus

also smoothed out.

The screen grids are decoupled by capacitors C4 and C5, which are electrolytic capacitors of high capacitance (25 μF), each having in parallel with it a paper capacitor of much lower capacitance (not shown in figure 3). Electrolytic capacitors have the advantage of a very small volume per μF, especially at the low working voltages occurring in this amplifier.

The objective of the paper capacitor is to ensure effective decoupling also at high frequencies, at which electrolytic capacitors have a fairly high impedance (their series resistance increases with frequency). A third electrolytic capacitor (C6) is connected across the anode battery, to avoid undesirable coupling across the internal resistance of the battery, which can become fairly high as the battery gets older.

Capacitive coupling is employed between the input and first tube (C1-R1), between the first and second tubes (C2-R2) and at the output (C3-R3), the second tube is DC-coupled to the third. The cathode connection is in each case the negative side of the battery. ➤

Grid bias for the first and second tubes is established with respect to the negative side of the filament, across the high-value leak resistors (R1, R2); this bias is increased slightly for the first tube by the voltage drop across the impedance Z1 which is part of the negative feedback circuit.

The slope of the tubes at the working point is about 0.1 mA/V; the input impedance is roughly 5 MΩ .

### Negative feedback

The negative feedback circuit is shown in figure 5. It consists of two impedances Z1 and Z2; a feedback of  $\beta = Z1 / (Z1 + Z2)$  is produced, this representing that part of the output voltage which is returned to the input. The ratio in which the amplification A (without negative feedback) is thereby reduced, is 1:  $(1 + \beta A)$ . In the present case A is about 4000 and the required amplification is  $A' = 100$ , so that  $\beta = Z1 / (Z1 + Z2)$  must be roughly 1/100. Variations in the amplification are thereby reduced in the ratio of 1:  $(1 + \beta A) = 1/40$ , which is sufficient to ensure that the amplification (except at the very highest frequencies concerned) is not reduced by more than 10% when all the battery voltages have dropped to one half their rated values. Non-linear distortion is also attenuated in a ratio of 1/40 and this is particu-



Figure 4. Detail of the circuit board containing the DL 67 pentode.

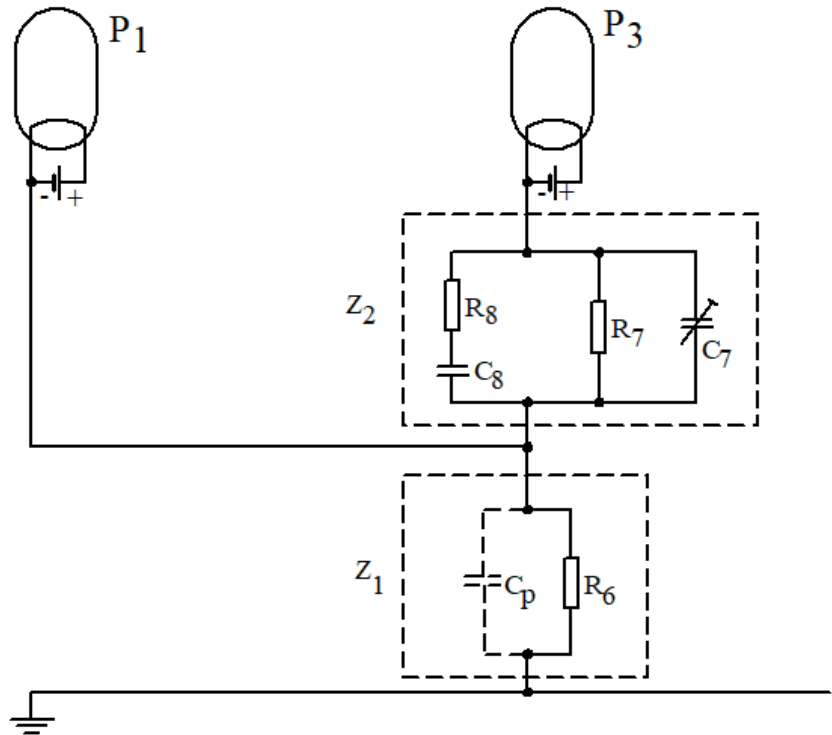


Figure 5. Detail of the negative feedback circuit of the amplifier.

larly important when the amplifier is employed with an oscilloscope. Figure 5 gives further details of the negative feedback circuit. At frequencies in the region of 1000 Hz the capacitances Cp and C7 may be neglected, and C8 can be regarded as a short circuit. Z1 then consists only of the resistor R6 and Z2 consists of the resistors R7 and R8 in parallel. The required amount of amplification  $(100 \pm 3\%)$  is obtained by using the appropriate value for R6.

In figure 5, Cp represents a stray capacitance, this being mainly the capacitance to earth of the filament battery for the first tube. At high frequencies the effect of Cp is not negligible, but this can be counteracted by means of a small trimmer C7, since the ratio  $Z1 / (Z1 + Z2)$  is independent of frequency when C7 satisfies the condition  $C7 (R7 R8) / (R7 + R8) = Cp R6$ .

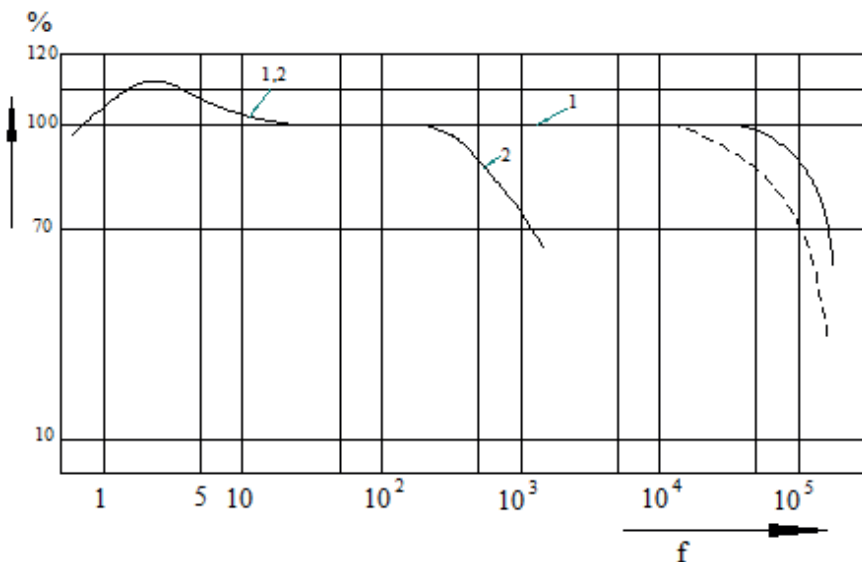
To ensure that voltages of square waveform will be amplified without distortion, C7 is very carefully adjusted, using a square-wave voltage of about 5000 Hz. The form of the output voltage of the amplifier is simultaneously checked with an oscilloscope which immediately

reveals any discrepancy in the adjustment. This is done in a way similar to the way we nowadays adjust our oscilloscope probes.

Owing to the finite time constants of the three RC couplings (C1-R1, C2-R2 and C3-R3), the gain is smaller in the low frequencies than in the middle of the range; to compensate this, the feedback network is so designed that the feedback is reduced with decreasing frequency. When the frequency is reduced, the capacitor C8 (figure 5) increases the impedance of the branch R8-C8 and hence also of Z2 so that the ratio of  $Z1 / (Z1 + Z2)$  decreases.

This compensation is not perfect, however; to ensure that there will not be too little compensation in any given frequency range, some over-compensation must be permitted in another range. This is the reason why the solid curve figure 6 rises slightly at frequencies below 100 Hz, to reach a maximum at 2 Hz, which on average over a number of these amplifiers is roughly 12% above the nominal value of the amplification. Consequently, a perfectly square wave





**Figure 6.** Amplification as a function of frequency.

of 12.5 Hz will be slightly distorted; at 25 Hz this distortion is almost imperceptible, and at 50 Hz it cannot be detected at all. Without the compensation, even a 50-Hz square-wave voltage would be badly distorted, and the compensation therefore ensures a useful increase in the range of frequencies for which the amplifier can be employed.

With a response curve of this shape (curve 1 in figure 6), obtained by means of the compensation mentioned, the unit is suitable for amplifying sinusoidal frequencies of from 1 to 150,000 Hz; with a square wave voltage the frequency range is 10 to 10,000 Hz. Even when all the battery voltages have dropped to half their rated values, the response curve retains the form shown, with the

exception of the extreme right-hand end, i.e., at the higher frequencies, where the drop becomes slightly steeper (dashed line in figure 6).

Where amplification of very small voltages within a limited range of frequencies is required, it is useful to be able to reduce the background noise at the expense of the bandwidth. Such conditions will often occur in investigations of mechanical phenomena, which are concerned with very low frequencies; the high-frequency end of the range can then be safely suppressed, thus eliminating the noise attributable to the higher frequencies. This is effectuated very simply by placing a capacitor in circuit (C9 in figure 3). The noise voltage, referred to the input is less than 10

$\mu V$  without the capacitor C9, but is less than 5  $\mu V$  with this capacitor in circuit. In this case the response curve of the amplifier is as shown by curve 2 in figure 6, this being suitable for the amplification of sinusoidal voltages at frequencies of 1 to 1000 Hz, and square-wave or pulse voltages of from 10 to 50 Hz.

### Additional design objectives

In the original article two more issues are discussed: forming of the electrolytic capacitors and microphony.

When looking at figure 1, two special positions are available on the main switch. These have to do with forming of the capacitors, a mechanism which will not be discussed here in detail. The reader is referred to the original publication. Microphony is the (mechanic) influence by vibrations (sound) on the position of the grids in the DL67. These vibrations may result in varying anode currents. In order to avoid possible trouble due to microphony when very low voltages are to be amplified, the amplifier chassis is flexibly mounted in the case.

### Conclusion

This description of the Philips GM4574 pre-amplifier clearly shows a number of interesting design choices made during the design of this piece of equipment such as feedback, frequency characteristic and noise behavior.  $\square$

- [1] [http://www.extra.research.philips.com/hera/people/aarts/\\_PhilipsBoundArchive/PTechReview/PTechReview-15-1953\\_54-169.pdf](http://www.extra.research.philips.com/hera/people/aarts/_PhilipsBoundArchive/PTechReview/PTechReview-15-1953_54-169.pdf) Philips Tech Review 17, 164-174, 1953; Volume 15 No 6
- [2] [http://www.extra.research.philips.com/hera/people/aarts/\\_PhilipsBoundArchive/PTechReview/PTechReview-15-1953\\_54-037.pdf](http://www.extra.research.philips.com/hera/people/aarts/_PhilipsBoundArchive/PTechReview/PTechReview-15-1953_54-037.pdf) Philips Tech review 15, 37 – 48, 1953 (no. 2), An electronic hearing aid; P. Blom
- [3] <https://en.wikipedia.org/wiki/Pentode>
- [4] [https://en.wikipedia.org/wiki/Hot\\_cathode](https://en.wikipedia.org/wiki/Hot_cathode)
- [5] <https://en.wikipedia.org/wiki/Transconductance>

# Calculating Resonances

## Bachelor column: a peek into the world of Electrical Engineering students

Michael Goddijn

In the previous column Shea told us about her rowing activities, and how she handles her studies next to them. Rowing five to six times a week can be quite demanding as she mentioned. Recently, she actually managed to take first place in this years nationals competition season with her crew, congrats Shea! In this edition of the Maxwell, she handed the column to Michael Goddijn. Michael is participating in the Honours Programme this year, and she had some question for him!

### What do you do in the Honours Programme?

In the Honours Programme I get the chance to perform a small research, guided by a researcher of the faculty. I am currently researching a way of determining the resonance frequency of a material. Here in I am guided by dr. Remis of the Department of Microelectronics, who bachelor students might know from the courses Signals and

ies during the week. I find it difficult to spend less time on the courses in order to also work on my research during the week, doing so will just stress me out when the exams are getting close.

### What are your plans for the minor?

Next year I am doing my minor abroad at KTH in Stockholm! Here, I can create my own minor by selecting interesting master courses. I have decided

### In what other activities do you participate?

This spring, I organised the ETV Rally with the 8th RaCie! Also, during this year I became a member of Outside, the LGBT student association in Delft.

An activity that also seems like a lot of fun is joining a DreamTeam. For the next column I am asking Laura Munteenaar some questions about her experiences at DARE. Laura, what makes being part of DARE so much fun? Is it tough to combine it with your studies? Do you have time for other activities? Do you already know what you want to do after this year?



*“I get the chance to perform a small research, guided by a researcher of the faculty.”*

Systems, or Electromagnetics. The research is a fun way of learning about subjects that are no part of the bachelor and it provides a great interaction with researchers of the faculty! Alongside this research I followed a course of the interdisciplinary Honours Programme, namely Leadership in a Complex World. This course concerned difficulties that modern-day leaders are facing, such as networking and framing. We also did a small research in a group of students from different faculties. During this research we interviewed a deputy director of a Dutch Ministry in Den Haag. That was quite an experience!

### Is it possible to combine it with your studies?

Yes, it is possible, but it takes discipline to work during the weekends when you already worked on your regular stud-

to follow courses on Plasma Physics and Space Physics. I can't wait to start these courses and go to Stockholm!



# Solar Energy MicroMasters

Master student column: a peek into the world of EEMCS Master students

*Mohammed El Makkaoui*

**In the previous column, Adithya Vemuri talked about how to manage time well and juggle between working at a Dreamteam while working on his Master's thesis at the same time. In this edition, Mohammed talks about how doing a PV MicroMasters program helped him with his master's degree in Electrical Power Engineering. Interested in pursuing a career in the field of Solar Energy? Read on!**

About four years ago, I graduated with a Masters in Chemistry from the University of California, Irvine. Though my degree was in solar energy materials research, I had to put my passion aside to work at my family's hotel in Freetown, Sierra Leone. I worked there for three years and it was quite an intensive, yet exciting experience. The problem was, I had been out of the photovoltaics (PV) field for so long that I was about to give up on my hopes and dreams of becoming a PV engineer or researcher, instead I thought I would end up being a hotel manager for the rest of my life.

It was a very intense struggle and a great part of me refused to give up on my dreams. In June 2017, I decided to look for online courses in solar energy, as an attempt to re-ignite my passion, and perhaps even find a way back into the field. That is when I found the Solar Energy MicroMasters course on edX, provided by TU Delft, through DelftX. I fell in love with the course. Not only did it help me reconnect with my passion, I found myself learning so much more and my appreciation for the field continued to grow. I ended up not only completing the program successfully, but also being the first student to finish that course series. While taking the third course, PV3x, on PV systems, I decided to apply for the Electrical Power Track (EPE) program in TU Delft. The program was devised such that if completed, a student may apply for the EPE or SET (Sustainable Energy Technology) programs at TU Delft and get exempted for up to 18 credits, and I wanted to

grasp that opportunity. The exemption allowed me to fill in my transcript with other courses related to power electronics and smart grids, so in addition to gaining so much knowledge in PV, the exemptions gave me enough room to explore the other fields of power engineering. Additionally, I am on the way to graduating as an electrical power engineer with a profile in both Solar Energy and Smart Grids. It did not stop there. The content I learnt in the MicroMasters provided me with a head-start going into the EPE program. I felt the material was already very familiar to me and I was able to excel in my studies. Completing the MicroMasters program also provided me with the opportunity to work as a community manager for

that same program, where I am now serving as one of the teaching assistants for the online course.

The MicroMasters program, provided by DelftX, was a life-changing experience for me. It is amazing how, in a matter of two years, I was able to get back on the PV track. I am very grateful for this program and consider it a privilege to have had the opportunity to be a part of it. I hope this program will continue to develop and aid the world in increasing its PV engineer population! Great thanks goes out to Dr. Arno Smets as well as the PVMD group and the teaching lab community for their brilliant work in Solar Energy Education.



# Integrated devices for neuronal ultrasound stimulation

*Dr. Tiago Costa*

Neuronal interfaces have been subject to very high research efforts in the last two decades, with the objective of providing therapies for diseases related to the nervous system. While pharmaceuticals have been generally effective, its non-targeted therapy typically gives rise to long lists of undesired side effects. Neuronal interfaces based on electrical stimulation, or electroceuticals, have been the most common alternative to pharmaceuticals, since they can provide targeted therapy by delivering electrical currents only in the target nerve of a specific brain area. Examples of these devices are the cochlear implant and the deep brain stimulator for Parkinson's

disease. However, one of the main limitations of most electroceutical devices is the need for surgical implantation of the stimulator, to achieve the necessary targeting and spatial resolution. In addition to the typical hurdles of surgery, implanting a device in the body presents a higher range of complications, accompanied by higher risks. As an alternative, non-invasive electrical stimulation devices have been developed, yet these suffer from reduced specificity and depth of targeting. In contrast, focused ultrasound has been emerging as a viable non-invasive therapeutic modality for diseases of the nervous system, with the potential of achieving

a safe, effective and surgery-free treatment option for patients. One of the most significant challenges in exploiting focused ultrasound techniques has been the very high levels of integration needed, due to the high spatial resolution requirements imposed by the specificity of the nervous system. The work developed at the Bioelectronic Systems Lab at Columbia University, and now continuing in the Bioelectronics group at TU Delft, targets the development of highly-integrated wearable devices for non-invasive electroceuticals based on focused ultrasound.



Neuronal interfaces have been widely developed in last decades with the purpose of providing a path for communication with the nervous system. The most common neuronal interfaces are based on electrical recording and stimulation of neuronal activity, which typically require surgical implantation of electrodes to achieve the necessary spatial resolution. To overcome the many hurdles and risks of surgery, non-invasive techniques to interface with the nervous system are currently being developed, and one of the most promising techniques uses focused ultrasound as a neuromodulation therapeutic modality. Due to its non-invasiveness, to achieve the necessary high spatial resolution, comparable to implantable electrodes, ultrasound transducers and electronics must be integrated in the same device. Its success may lead the way to surgery-free neuro-prosthetics and electroceuticals.

### Ultrasound neuromodulation

Ultrasound is a mechanical pressure wave with frequencies above the human hearing range ( $> 20$  kHz). In body tissues, ultrasound waves typically have high propagation depths, low scattering and average to high contrast between different body structures. For this reason, ultrasound imaging is one of the most widely used imaging modalities in medical diagnostics. On the other hand, the use of ultrasound for neuronal stimulation, even though first observed in the late 1920s, has been largely overlooked up until a decade ago, where researchers, taking advantage of more advanced technologies and increased knowledge on the nervous system, have been exploiting this promising non-invasive therapeutic modality [1].

For both ultrasound imaging and neuronal stimulation, ultrasound waves need to be focused in the region of interest in the body tissue, either to compose a diagnostic image based on the received echoes or to stimulate a specific region of the nervous system. Ultrasound imaging transducers are based on the concept of phased arrays (Fig. 1), where an array of ultrasound transducers is driven by very short bursts ( $< 5$   $\mu$ s) of either sinusoidal or square voltages with a specific time delay that, when converted into the ultrasound domain, allow for the constructive interference between the pressure waves in a specific focal region. On the other hand, ultrasound neuronal stimulation requires longer ultrasound bursts ( $> 100$   $\mu$ s) and typically higher focal pressures when

compared to ultrasound imaging. For that reason, researchers typically use single-element focused transducers interfaced with off-the-shelf electronics,

*“The goal of our research is to develop a device that is compatible with both ultrasound neuronal stimulation and imaging”*

to allow for higher configurability of burst duration and pressure to achieve neuronal stimulation.

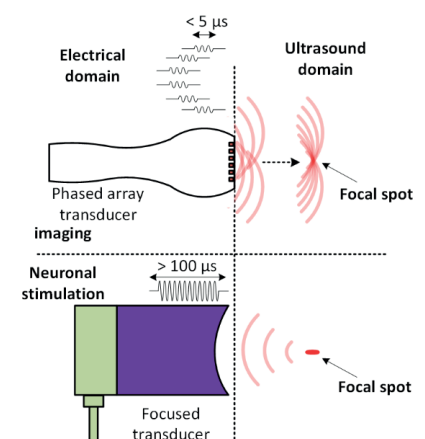
Even though focused transducers have been helping researchers advance the field of ultrasound neuronal stimulation, such transducers are still very bulky, require both off-the-shelf instrumentation and mechanical manipulators to change the focal spot location, and do not allow for concurrent imaging. The goal of our research is to develop a device that is compatible with both ultrasound neuronal stimulation and imaging in an integrated and wearable form factor, by merging the concept of phased array transducers with the specific requirements of ultrasound neuronal stimulation.

### The need for integration

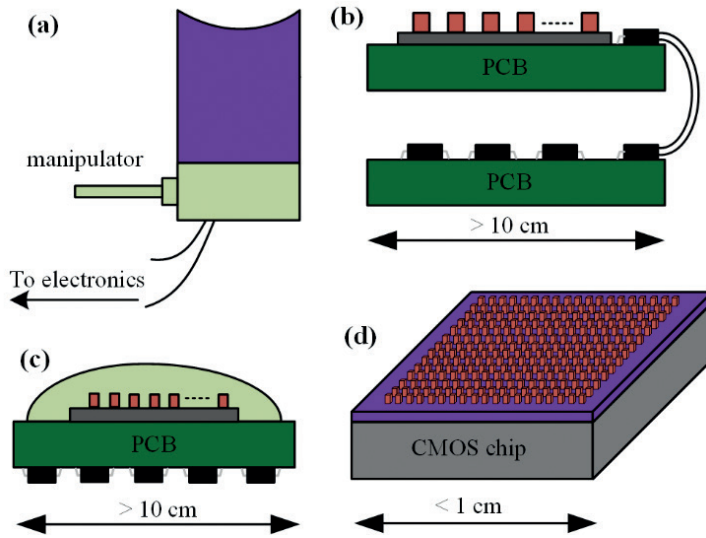
The typical ultrasound frequencies of medical ultrasound range from sub-MHz to several MHz, which corresponds to wavelengths from several mm down to a few hundred  $\mu$ m. For a phased array to generate the desired focused

wave, the spacing in between each transducer needs to be smaller than one wavelength. While the single-element focused transducer of Fig. 2.a can be manufactured without this requirement, phased array transducers at different frequencies can lead to different ways of designing and packaging the required electronic instrumentation.

In the frequency range of sub-MHz to 1 MHz, the spacing in between elements is still above 1 mm, which leaves enough space for all the required interconnections between each transducer and the corresponding electronics. In this case, one can envision a system like the one in Fig. 2.b, where transducers and electronics are designed in different substrates and connected by a flexible cable.



**Figure 1.** Phased array transducer for medical imaging and single-element focused transducer for neuronal stimulation.



**Figure 2.** (a) single element focused transducer. (b) phased array transducer and interfacing electronics in different substrates. (c) phased array transducer and electronics in same package. (d). phased array transducer integrated directly in a circuit chip.

On the other hand, if the frequency enters the MHz range, the inter-element spacing is now below 1 mm, which means that not only the spacing for interconnections is reduced, but the parasitic capacitances of the interconnections also start to interfere with the signal integrity. For this reason, transducers and electronics need to be as close as possible, for instance designed like in Fig. 3.c, by sharing the same board and avoiding long cables.

Ultimately, to achieve very high spatial resolution in ultrasound neuronal stimulation, the frequency needs to be in the high end of the spectrum, approaching 10 MHz. This means that spacing for interconnections is now at the minimum value, and parasitic capacitance effects are at its maximum. In addition, the area for the circuit instrumentation per each transducer is now as low as 100  $\mu\text{m}$  x 100  $\mu\text{m}$ . For this reason, integrating the ultrasound transducers directly on top of an integrated circuit chip is unavoidable, as illustrated in Fig. 2.d.

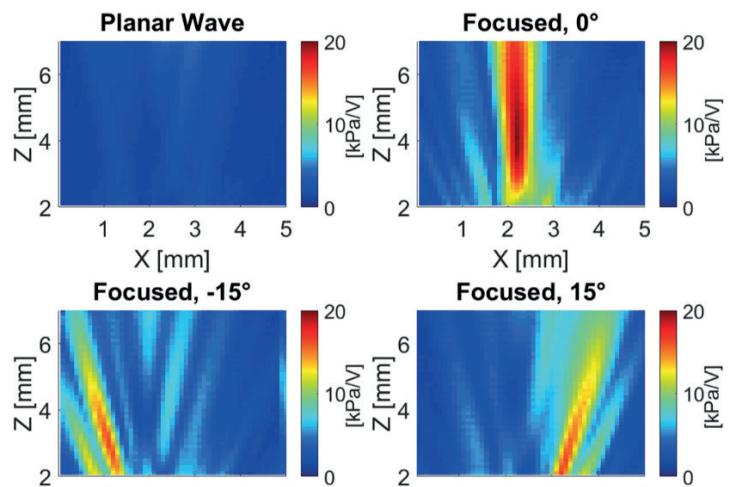
To implement this fully integrated device, we developed a fabrication method as described in Fig. 3 [2]. The ultrasound transducer, firstly as a single block, is mechanically and electrically connected to the CMOS circuit interface chip, by using an anisotropic conductive adhesive. As seen in Fig. 3.b, the adhesive contains conductive particles with very low density, to guarantee that there are no short circuits between adjacent transducers. Following this adhesion

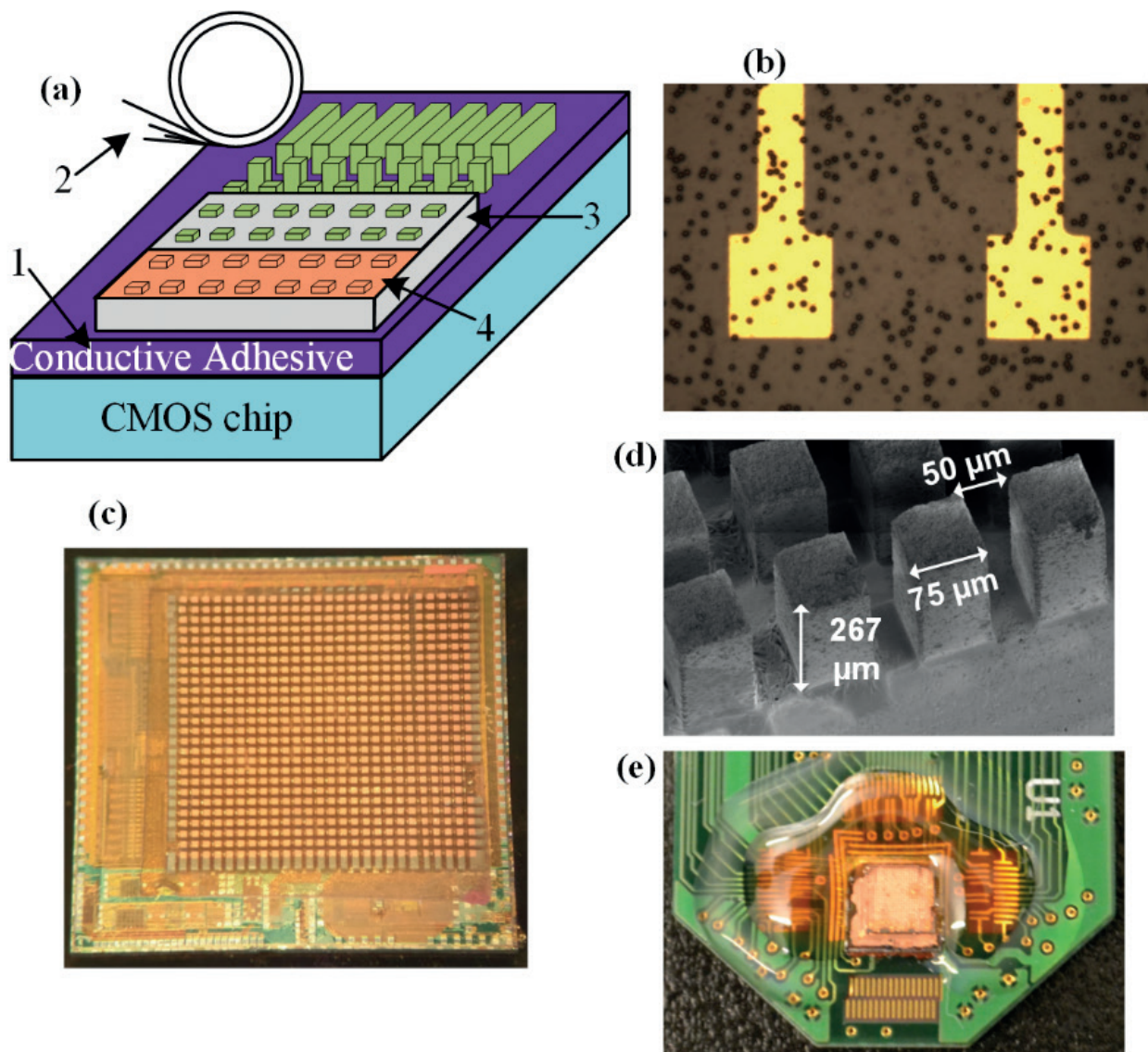
step, the transducer is converted from a single block into a 2D array of pillar structures by using a tool, equipped with a dicing saw with a thickness of 50  $\mu\text{m}$  and performing cuts in two perpendicular directions in order to obtain the desired shapes as seen in Fig. 3.c, and in the more detailed photo of Fig. 4.d. Finally, a non-conductive epoxy is applied in between the transducer array to increase its mechanical stability, and a ground plane is deposited on top of the array. The once separate integrated circuits and ultrasound material then became a single device capable of generating focused ultrasound waves, as seen in the measurements of Fig. 4 [3].

By achieving full integration, the number of transducers can be increased in order to provide the necessary pressure levels for ultrasound neuronal stimulation, while using the integrated electronics to precisely focus and steer the focus spot into the desired location in the nervous system. Next steps will include the addition of imaging capabilities and increasing the ultrasound frequency to further improve the spatial resolution of the neuronal stimulation, which will create very interesting integration challenges.



**Figure 4.** Ultrasound measurements from integrated device: planar wave (all transducers with same delay), focused wave with steering angles of 0, -15 and +15 degrees.





**Figure 3.** (a) Integration method of ultrasound transducers directly on top of CMOS chip: adhesion (1), dicing (2), kerf filling (3) and ground plane (4). (b) Anisotropic conductive adhesive, showing the conductive particles. (c) 2D array of 26x26 ultrasound transducers after dicing step. (d) Scanning electron microscope photo of transducers. (e) Fully integrated device, packaged in a PCB.

- [1] Y. Tufail et al., *Neuron*, vol. 66, no. 5, pp. 681–94, Jun. 2010
- [2] C. Shi et al., *IEEE International Electron Devices Meeting (IEDM)*, 2018, p. 4.5.1–4.5.4
- [3] T. Costa et al., *IEEE Custom Integrated Circuits Conference (CICC)*, 2019, to appear

# Smart fridge scale

## DIY project

Bob van Nifterik and Sebastian Jordan

As a student you have to deal with a lot of responsibilities. It is all over the news that the work load is increasing and more students suffer from severe stress. Getting your BSA, social life, doing groceries, you have to manage all these things yourself. Today this tide will turn by removing one big stress factor: knowing if there are enough drinks in your fridge.

### Concept of a smart fridge scale

Imagine this; you have just finished a hard day of work with a group of people. Wanting to relax, you invite a whole bunch of people over to your house for drinks. However, once you arrive at your house and open the fridge, you make a shocking discovery. There are not enough drinks left in the fridge! This problem can be solved by making a smart fridge scale that you can access remotely to get an accurate count of the amount of bottles in your fridge.

The idea is simple, a scale has to be put underneath the drinks fridge and connected to the internet. Then when drinks are added, the scale measures the load. Knowing the weight of a single bottle, the amount of drinks in the fridge can be calculated. Then, when not at home, you are able to check if there is a cold friend waiting for you.

The components needed to make this speak for themselves. You will need pressure sensors and a device that can link the scale to the internet. The link to the internet can easily be made by using a Raspberry Pi. Although a Raspberry Pi is not the cheapest option and slightly overpowered for this job, it will give you a stable connection. This is after all not a system that you want to fail. Also, a bunch of features could be added to the device in a later stage.

The pressure sensors are more difficult to source. There is a wide variety of pressure sensors, but they are quite ex-

pensive and are all rated in very specific weight ranges. To solve the pressure sensor issue you can make good use of an old friend: The Wii balance board!

### Wii balance board

The Wii balance board has fallen into oblivion and is almost never used anymore. A fridge scale is therefore a good way to recycle your old game controller. The sensors are exactly in the range of full fridge (max 150kg). The connection with the balance board can easily be made by Bluetooth. There is a wide variety of tutorials available on how to make a connection with a to a Wii controller using a Raspberry Pi [2]. A normal Wii balance board uses replaceable batteries. Changing the batteries every now and then is not very practical, as the device needs to be turned on continuously. Therefore, an adapter can be bought to replace the batteries with a power supply that you can plug into an USB port [1].

### Analysing the data

Once you are able to read out the balance board with the Raspberry Pi, a start can be made towards analysing the drinks data. Python code that analyses the data is already available online [3].

To properly analyse the amount of drinks, there always must be the same stacking procedure. This means: with a "crate" or without. The easiest way to do this is without and just stacking the bottles in the fridge.

Because the balance board has 4 sensors, it can measure the weight distribution in the fridge. So now you will be able to know if you are a right stacker or left stacker.

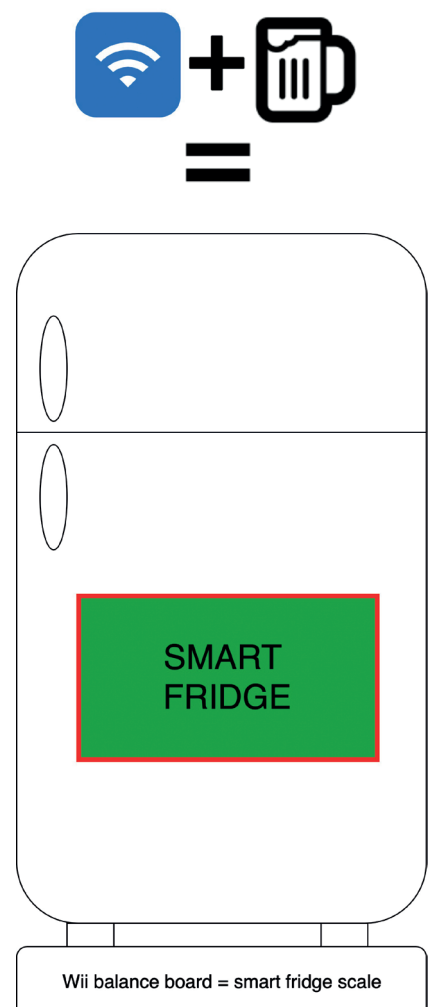
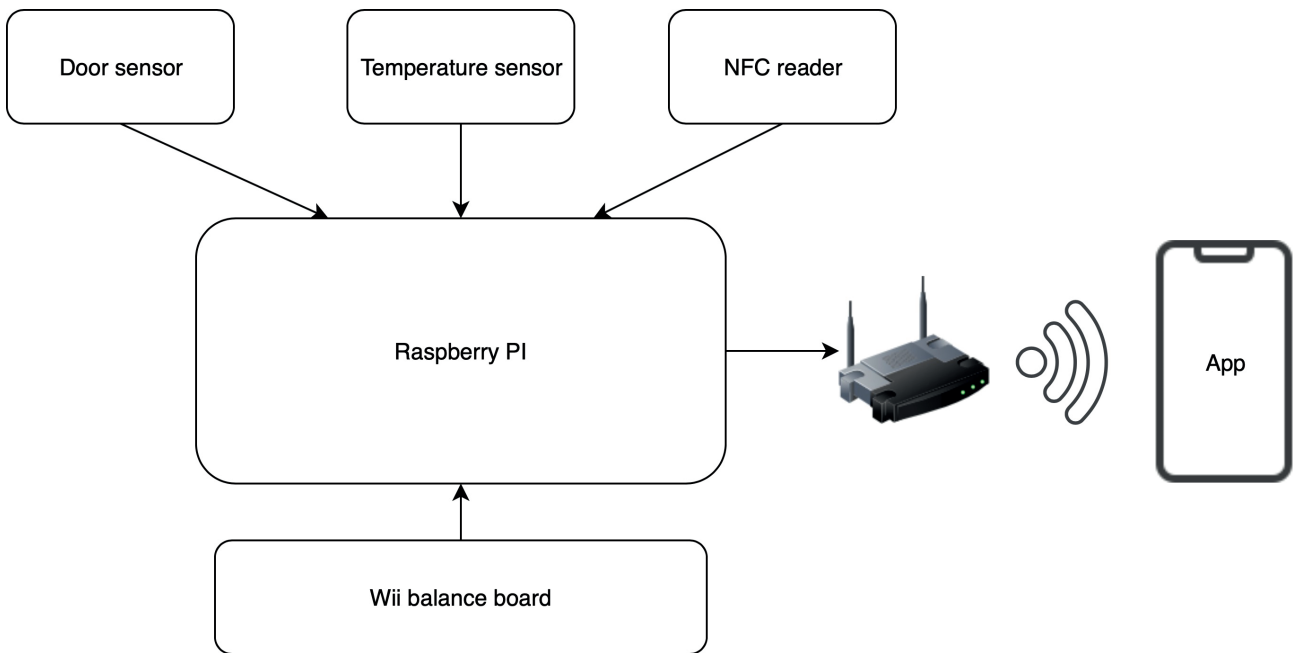


Figure 1. Smart fridge





**Figure 2.** Schematic overview of the total system

### Additional features

Some nice features to implement are of course; knowing the amount of drinks in your fridge, but also the feature to calculate if the drink has been in the fridge long enough to be icy cold. For this feature, some measurements would need to be done. Next to that, a temperature sensor would be needed.

To implement these features, an additional sensor is desirable. This sensor will check if the door is open or closed. There are different sensors that can be used. The reason why this is desirable is to get a start signal for a measurement.

So only when the door is opened the variables of weight can change. This makes the system a lot more fail proof.

### Tally system

The data gathered gives many possibilities in analysing your healthy student lifestyle. There is one adaptation of this data that is of interest in most student homes: taking care that everyone that has a drink, pays for it. Keeping a tally is a simple solution for this. Because the change in drinks is known, the tally can be checked. Roommates therefore can not be taking drinks from the fridge without paying. An implementation

of this system could be a personalised NFC card that has to be scanned when opening the fridge. Once the fridge closes, the system will calculate the new amount of drinks and put the difference on your tally.

### Final remarks

We have not yet implemented the smart fridge ourselves. However, we have all the components we need and now our bachelor thesis has been handed in, we have enough time to make it happen. This way we can enjoy the smart fridge during hot summer days.



- [1] [https://www.beslist.nl/accessoires/d0030359850/Batterij\\_Oplader\\_voor\\_Nintendo\\_Wii\\_Balance\\_Board.html?productIdentifier=00000171798722199850965777848&utm\\_medium=paid-search&utm\\_source=google-shopping&utm\\_campaign=Multimedia-accessoires%7C69210605674&device=c&network=g&gclid=aw.ds](https://www.beslist.nl/accessoires/d0030359850/Batterij_Oplader_voor_Nintendo_Wii_Balance_Board.html?productIdentifier=00000171798722199850965777848&utm_medium=paid-search&utm_source=google-shopping&utm_campaign=Multimedia-accessoires%7C69210605674&device=c&network=g&gclid=aw.ds)
- [2] <https://electronics.howstuffworks.com/wii-balance-board2.htm>
- [3] <https://makezine.com/projects/create-raspberry-pi-smart-beer-fridge/>

# Activities

An overview of last quarter's events



## Dies Natalis 113

13 - 17 May

On the 13th of May, the 113th Dies Natalis week started. It was a fun week filled with entertaining activities like VR gaming, a beer tasting and a BBQ with good food. I am proud to have been a part of the ambitious committee which was responsible for ensuring that everybody enjoyed themselves. We worked well together, which meant that we had a good time in doing so. My favourite activity was the Diesco party for sure. I was responsible for the organization of this activity, so it was important to me that everything was taken care of. Luckily, we found a great location where the party could be held. Everybody had a great time!

*Sam Aanhane*

## Dies: VR gaming

15 May

As one of the committee members, I had a great time organizing and taking part in every activity. I was responsible for one of the highlights of the week: the VR gaming session. The event took place at a company based in Delft. Their branch had two big halls where players competed against each other in teams of five. With the goggles on your head and a gun in your hands, the goal of the game was to shoot as many zombies as possible. I had a great time and everything looked very realistic!

*Joost van der Weerd*

## Dies: Laplace to be

5 May

When we first revealed the theme of this year's Dies Week, a few eyebrows were raised. To the uninformed reader, the theme only appears to be a bad pun which was chosen because the committee could not come up with a better idea. It might seem like a lazy alternative to a clever theme that other committees have come up with in the past. Some might even say that it is bad, because it is not directly related to Electrical Engineering. Well, those people are wrong and should inform themselves. In order to achieve this, you can ask a member of the Dies Committee to explain the subtle intricacies of this great theme. We would love to enlighten you.

*Joris van Breukelen*



## Rally

5 May

Mario Kart: one of the most fun racing games out there, playing with or against friends, competing in different cups for the grand prize and everlasting fame. Imagine an activity that embodies this experience in real life. You got it right: it is the ETV Rally! This year, seven cars filled to the brim with ETV members competed against each other for the everlasting fame. The objective of the participants was to travel the least amount of kilometres while completing fun and exciting challenges along the way to earn a kilometre subtraction. The day was divided into eight sections in line

with the eight Mario Kart cups. In each cup, a different puzzle or challenge to get to the next checkpoint was presented to the teams. As an addition, each team received an item box filled with bananas, mushrooms and balloons to ensure all the teams could hamper each other's progress with Mario Kart power-ups! The day came to a close by dining with the participants in an excellent Italian restaurant. We want to thank everyone for participating! We from the 8th Rally committee had a great day!

*Jasper-Jan Lut*



## Yearbook presentation

4 June

Every year, a book is made about our association. It contains information about past year's activities, its committees, the current and previous Board and much more. After the book has been made and printed, it is presented at the Yearbook presentation. Normally, this activity takes place somewhere during the Dies week, but this time it took place a couple weeks later - on June 4th to be exact. The main part of the event is the presentation of the book and having your own book signed by the Yearbook Committee (JaBo). Since this takes a while, there was karaoke and sushi (made by the future EOW committee) to pass the time. This all was accompanied by a sufficient amount of free beer. Overall, I would say that it has been a great evening and I would like to thank my committee for Potentially making the best yearbook since "Stoppen".

*Tim Plantfeber*

## Interfaculty Beerpong Match

6 June

This year, the third edition of the "annual" Interfaculty Beerpong Tournament (IFBT) took place. For this edition, associations of the faculties 3ME, TNW Zuid and EEMCS participated. It was organized by Froude, Hooke, Life, Variscopic and the ETV! It started with a pool phase, after which a knockout phase took place. After a bloodcurdling battle, in which a lot of beer flowed, a team from LIFE eventually won. It was again a great evening with lots of fun, and it was very nice to meet people from other associations. I am looking forward to participating in again next year!

*Willem de Laat*



# Study Collection

An early tone generator by L.M.H. Huydts. An addendum to the article on the Philips GM 2307 tone generator.

Kees Pronk

In Maxwell issue 22.2 the Philips GM 2307 tone generator has been discussed. This tone generator from 1943 is based on the heterodyne concept. As explained in that article in the heterodyning concept two high frequencies are mixed to obtain the required low frequency output signal. Shortly after the publication of that issue, Kees Wissenburgh one of the colleagues of the Study Collection, remarked that the use of the heterodyning principle in tone generators was much older and that he remembered a similar tone generator having been displayed in the Kanaalweg-building where the Faculty of Electrical Engineering was located before 1970. He even mentioned a name: professor Huydts.

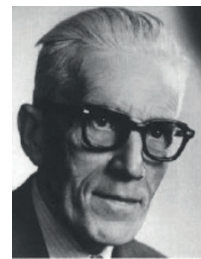
After some investigations the following information was obtained:

The tone generator was developed around 1929 by L.H.M. Huydts and L. v.d. Bilt and is still present in the Academic Heritage Collection of the TU Delft Library, Special Collections. Thanks to S. Nijhuis from the library we were able to make some photographs of the machine which you may find in Figures 1 and 2. Apparently, the frequency range of the generator is from 150 Hz . . 20 kHz. Two vacuum tubes having been used and several honeycomb coils may be seen. Unfortunately, no tube numbers and no schematic are available. Unlike the industrial Philips GM 2307, the tone generator by Huydts is an experimental

design.

Professor ir. L.H.M. Huydts was a honorary member of the ETV from 1955 to 1974. More information on professor Huydts may be obtained from the web site <http://evt.tudelft.nl/etv/ereleden/huydts> (see also Figure 3). The text on this web-site even mentions the development of a tone generator based upon the heterodyning principle.

Professor Huydts presented his inaugural address entitled: *Electronica als hulpmiddel voor metingen en wetenschappelijke onderzoeken* (Electronics as an auxiliary field for measurements and scientific research) in 1946. This inaugural address is still available



**Figure 3.** Prof. ir. L.M.H. Huydts

from the library at our university at <https://repository.tudelft.nl/islandora/search/huydts?collection=research>.

It is quite interesting to read about the scientific challenges discussed in those days such as the use of negative feedback. ☞



**Figure 1.** Front view of the tone generator



**Figure 2** Top view of the generator (with panels removed)



Creating  
an autonomous camp  
that is less dependent on  
third parties, preferably  
with the help of  
solar energy

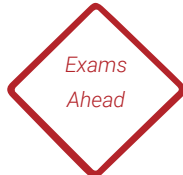
*“An aim that did not turn out to be feasible for every  
refugeecamp. Last year, the EfR-team has made a huge  
improvement in the life of refugees at Lesvos by installing  
solar panels on a school camp called Kara Tepe which  
resulted in reliable energy without disruption during  
the education of the children. This year, the EfR-students  
will provide the refugee camp Olive Grove on Lesvos  
with a sustainable energy system.”*

Read more on: [www.tudelft.nl/en/eemcs/current/nodes/stories](http://www.tudelft.nl/en/eemcs/current/nodes/stories)

# Upcoming Activities

For members of the Electrotechnische Vereeniging

Lotte Zwart

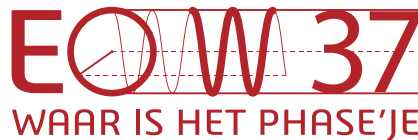


For some, the year has finished and all is well. For the freshmen bachelor students, this means that their BSA is in and for the freshman masters this means that next year they can start their thesis.

But for the poor unfortunate souls that didn't pass all the exams, summer resits are coming. Best of luck in the upcoming weeks and we see you all (hopefully) next year!

**When:** See mytimetable.tudelft.nl

**Location:** See mytimetable or Osiris



Every year the freshman bachelor students are welcomed at the EOW (Elektro Opening Weekend). This year will be no exception!

Half-way August we will welcome them at the faculty where the dean will give a talk and we formally welcome them. Afterwards we will go to the campin-ground, at which we will do a lot of fun integration activities and they can get to know the association!

**When:** 15<sup>th</sup>-18<sup>th</sup> of August

**Location:** EEMCS faculty

**Price:** €50



The master students are also welcomed at the beginning of the year. On the 30<sup>th</sup> of August they will meet their fellow students, their teachers and the studyassociations. Sign up at: <https://tu-delft.foleon.com/tu-delft/master-kick-off-eemcs-2019/home/>

**When:** 30<sup>th</sup> of August

Arrival & Meet 'n' Greet: 11-13

Welcoming speech: 13-13:45

MIM 13:45-15

Master your start award 15-17

Welcoming Drinks 'n' Bites 17-18:30

**Location:** EEMCS

**Price:** Free

## Back to school



For the rest of us non-freshmans, it is back to university time. On the second of September the lectures will start again. Best of luck to all trying to start up again!

The ETV will be sparsely, if at all open during the summer. From the 2<sup>nd</sup> of September onwards we will re-open on business days from 8:30 until 17:30 for all your questions, new notebooks and books for the coming quarter. Enjoy the summer holidays!

With the new year, also comes a new board. On the yearly general assembly we will decide on many important topics for the association, but we will also change the board. If all goes well the division of functions for next year will be:

- President - Shea Haggerty
- Secretary - Sam Aanhane
- Thresurer - Max Deutman
- Com. External - Thomas Pouwels
- Com. Education - Joos Vrijdag

**When:** 10<sup>th</sup>-11<sup>th</sup> of September

**Location:** Study museum



In the first quarter we will immediatly also have a lunchlecture and a workshop by the company Technolution.

Technolution is a company that combines hardware and software. In this combination is their strength. They put this to work to make effective, future-oriented solutions. Solutions that have inpack in society.

**When:** Luchlecture 8<sup>th</sup> of October

Workshop on 23<sup>rd</sup> of October

**Location:** Boole and TBD

**Price:** Free



# > Hardware en software met elkaar laten praten

## Dat wil ik!

Ik heb altijd een duidelijk doel voor ogen gehad: werken met computertechnologie. Dat heeft mijn studiekeuze bepaald en daarna mijn keuze voor Technolution. Projecten waar hardware en software elkaar raken, daar wordt het voor mij echt spannend. Wat wil jij?

**Leon Noordam**  
Afstudeerder

[www.technolution.nl/leon](http://www.technolution.nl/leon)



Ontwerp jij het energienet van de toekomst?

# Word technisch trainee bij Alliander

Hoe zorgen wij dat we in 2050 van het aardgas af zijn? Binnen hoeveel minuten lokaliseer je een storing via een tablet? Welk vermogen heeft een transformator in een woonwijk nodig? Als technisch trainee geef jij het antwoord.

Heb jij jouw technische studie (bijna) afgerond? Dan is het technisch traineeship bij Alliander misschien iets voor jou. In dit tweejarig traineeship werk je aan energietechniek op het hoogste niveau. Zo groei je snel door naar een functie als consultant, engineer, projectmanager of asset analyst.

Meer weten? Kijk op [werkenbijalliander.com](https://werkenbijalliander.com) en ontdek jouw uitdaging.

Ruimte voor  
jouw energie

**alliander**