

# MAXWELL

Electrotechnische Vereniging

Issue 22.1 | November 2018

## Durability

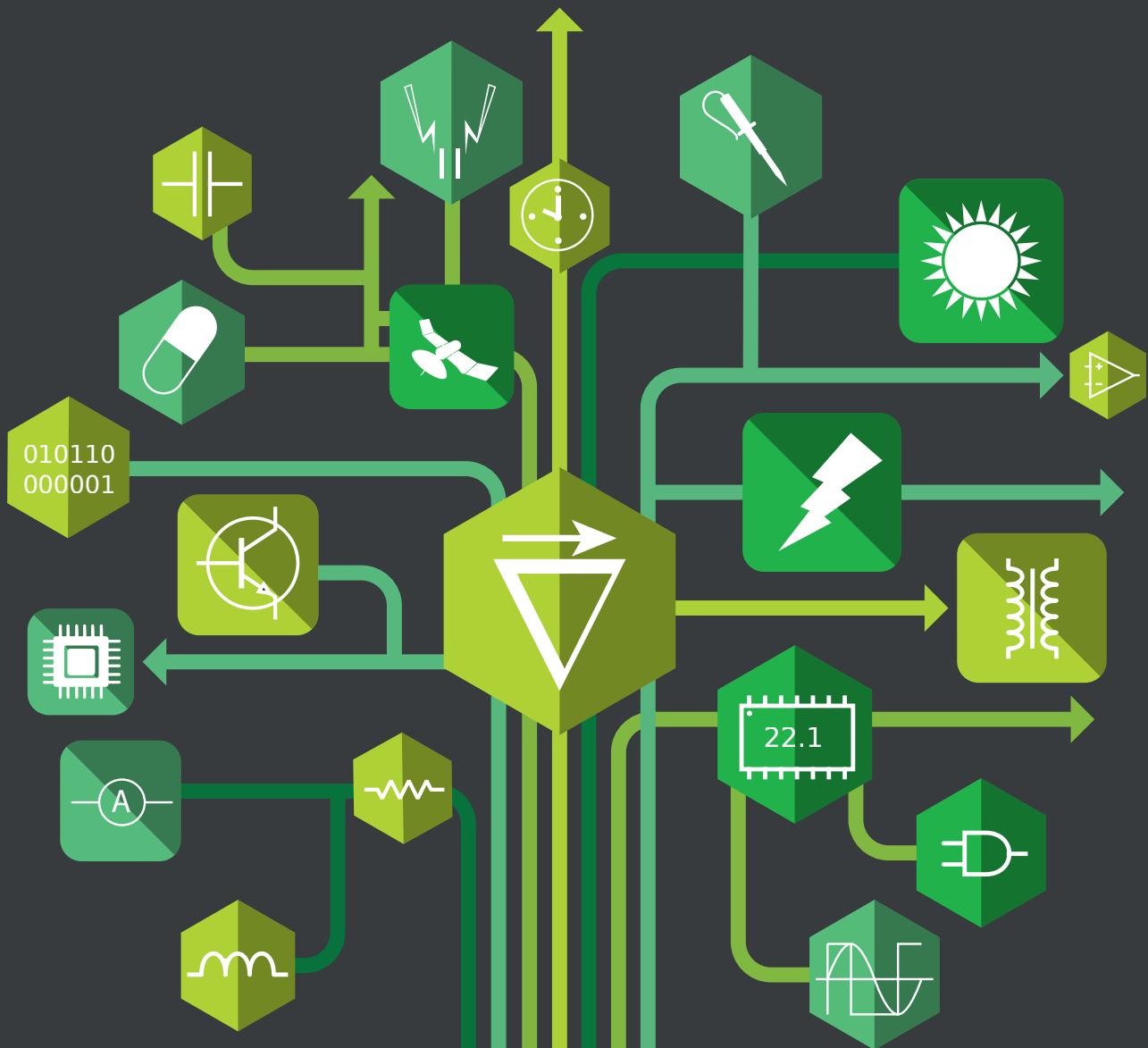

### **Exploring the past with future radio telescopes**

When Big Bang meets Big Data

### **Lightning Protection of Power Systems**

How to protect power systems from severe external disturbances

### **Electromagnetic Compatibility aspects of Cabling**

TU Eindhoven in collaboration with ITER

# >topplek voor jouw bijbaan



Waarom wachten tot je bent afgestudeerd? Kies nu al voor een baan in een dieptechnologische omgeving - een bijbaan! Werken met vakgenoten waar je jouw technische kennis nu al kan inzetten. Bij Technolution krijg je die kans. Jouw werkplek staat zelfs al klaar.

[www.technolution.eu/bijbaan](http://www.technolution.eu/bijbaan)

>dieptechnologisch

# From the Board

## Commissioner of Education

*Lotte Zwart*

Dear reader,

A new year has started and so have I! This year, I have taken over the role of Commissioner of Education from my predecessor Thomas Roos. Therefore, it is my job to monitor our education and to improve it. In this section, I will update you on everything that has happened and on what will happen education-wise in this quarter.

To start off, this year I am working with a new concept for feedback. It will only be for the freshmen this year, yet this concept will work its way up through the other years as well. In the past, bachelor students were lured to the focus groups with free lunch. This was not necessarily a bad system, however there are better systems with better motivational reasons to join a focus group.

This is why this year, the freshmen have a 'Year Representation' (*jaarvertegenwoordiging-etv@tudelft.nl*). They will be talking with their peers, teachers and me. This will lead to a faster signalling of problems and it will increase the approachability of the teachers that the students see every day.

Besides the Year Representation, there is another exciting update! Thomas had already introduced it in the previous Maxwell, however now it is almost definitive: we are switching to a new book supplier. The book sale service of the ETV has not been up to par. This was mainly due to the fact that our previous supplier was unfortunately inconsistent in the delivery of the books. Luckily, from the second semester onwards, the VSSD (the Students' union of Delft), has taken it upon their selves to improve the book-buying experience of our students, which will hopefully lead to proper delivery as well as improved exam results for our students!

Furthermore, in the coming years a new curriculum for the bachelor programme will be designed. Currently I am involved in a committee that will decide on what will be relevant for the curriculum for the coming 10 years. If you have any suggestions or subjects, please let me know!

If you have any complaints (or compliments) regarding education, you can always contact me at *education-etv@tudelft.nl* (or walk by!).



## President

*Laurens Vergroesen*

Dear reader,

It has not been that long since we were installed as the 147<sup>th</sup> Board, however a lot has happened already. Throughout this year, you as a member and us as Board will have many new experiences.

As President, I have to guide the association on the right course. Together with my Board members, we want to make the ETV thrive even more in our short mandate. The time has come to start looking further, by developing and improving not only the association - also ourselves. A Board year offers you the opportunity to write a piece of history. While doing so, we will grow individually and as a group. New skills must be learned to achieve our ambitions for the ETV. This means spending much time learning and working in the Boardroom or at home, alone or together.

And now that the first quarter is over, our Board has grown very close. Spending 5 days a week together ensures that you create a special bond in no-time. Try to get the most out of your study time, and enjoy it as much as you can. I hope to see you soon in the boardroom!



# Colophon

Year 22, edition 1, November 2018

## Editors

Mathijs van Geerenstein  
Sebastian Jordan  
Bob van Nifterik  
Medha Subramanian  
Karen van der Werff  
Stefanie Brackenhoff

## Contributors

D. Beltram, R. Bokhorst, J. Christiaanse, A. van Deursen, B. Dikker, V. Giagka, M. Goddijn, R. Heusdens, A. Joyandeh, D. Kappelle, T. Moree, S. Naghibzadeh, K. Nanbakhsh, B. den Ouden, S. Patel, M. Popov, K. Rodewijk, T. Salden, W. Serdijn, A. van der Veen, J. Vrijdag, F. Walterbos

## Advertisements

Page 1 - Technolution  
Page 19 & 20 - Allseas  
Page 28 - HyTEPS

## Printing

Quantes, Rijswijk, 1400 copies

## Electrotechnische Vereeniging

Mekelweg 4  
2628 CD Delft  
The Netherlands  
Phone number: +31 15 278 6189  
Email: board-etv@tudelft.nl  
Website: www.etv.tudelft.nl

## 147<sup>th</sup> Board of the ETV

President - Laurens Vergroesen  
Secretary - Philip Groet  
Treasurer - Willem de Laat  
External Affairs - Franck Kerkhof  
Education - Lotte Zwart

## Subscriptions

Non-members can get 4 issues of the Maxwell against an annual contribution of €10,-.

## Change of address

Please send changes in your address to the (e-mail) address above or use the website.

# Editorial

*Mathijs van Geerenstein*



Dear reader,

New year, new me? New year, new Maxwell committee! The academic year has kicked off to a new beginning and with six new members in the Maxwell committee, we are determined to entertain you with Electrical Engineering-related content once again!

We always try to provide you with the most interesting articles, either from professors and students from the EEMCS faculty, a DreamTeam or even other universities. As you might know, there is a lot of research being conducted in all the different fields of Electrical Engineering - so how do we select the articles for each edition?

This is done by giving editions a theme, similar to previous years. This edition's theme: durability. It is a very broad concept, which is also what the articles in this magazine will show. It covers topics in the micro-range such as bioelectronic medicine, up to articles in the macro-range including the lightning protection of power systems. Please enjoy the first edition of Maxwell 22.

Happy reading!



# Index

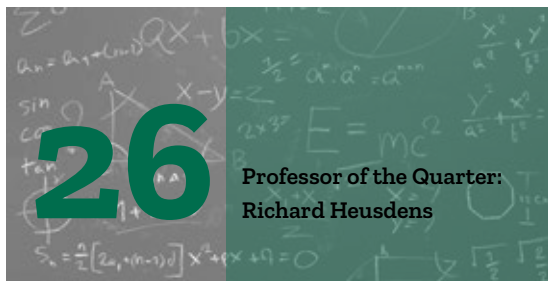
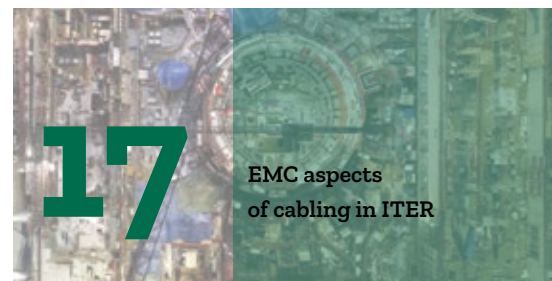
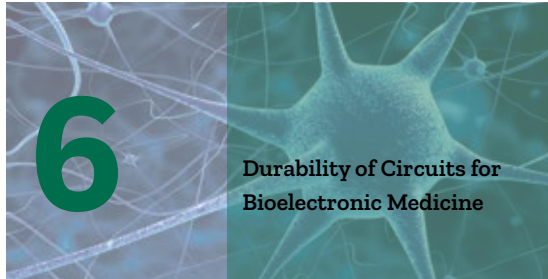

DreamTeam: Forze	12	29	Specialist in power quality
Development of semi-automatic offshore crane	20	31	DIY-Room: Touch sensors
Power quality and Sustainable Energy Systems	22	32	Activities
RF energy harvesting for IoT sensors	24	34	Communications of EEMCS
Faculty Student Council	28	35	Quarterly flyer

# Bioelectronic Medicine

## Durability of Electronic Circuits for Bioelectronic Medicine

*MSc Kambiz Nanbakhsh, Prof.Dr.Ir. Wouter Serdijn and Dr. Vasiliki Giagka*

Imagine a tiny device that can treat patients by injecting small electrical pulses into the neuronal tissue. These tiny microelectronic devices are the main focus of a new exciting field called **Bioelectronic Medicine**, with the main goal of one day replacing conventional chemical drugs. When implanted, these devices can act on the body's nervous system to treat a wide variety of disorders, such as rheumatoid arthritis, obesity, Crohn's disease, migraine, epilepsy, etc.<sup>[1]</sup> The technological challenges behind realizing such devices, however, are enormous and encompass almost every facet of microfabrication and bioengineering technologies.

### Challenging requirements

Microsystems for bioelectronic medicine are envisioned to record, process data and stimulate or interact with small groups of neurons. Thus, these devices rely on specific electronic components and circuitry for realizing their functionality. Fig. 1 gives a systematic breakdown of such an envisioned implant. Given the relatively small and delicate nature of our nervous system, these devices should have a small form factor ( $< 1 \text{ cm}^3$ ), with minimal weight ( $< 1 \text{ g}$ ) and be flexible enough to target single nerve bundles without causing any harm. In addition, the device should maintain long-term durability in the harsh ionic environment of the human body, ideally for a lifetime.

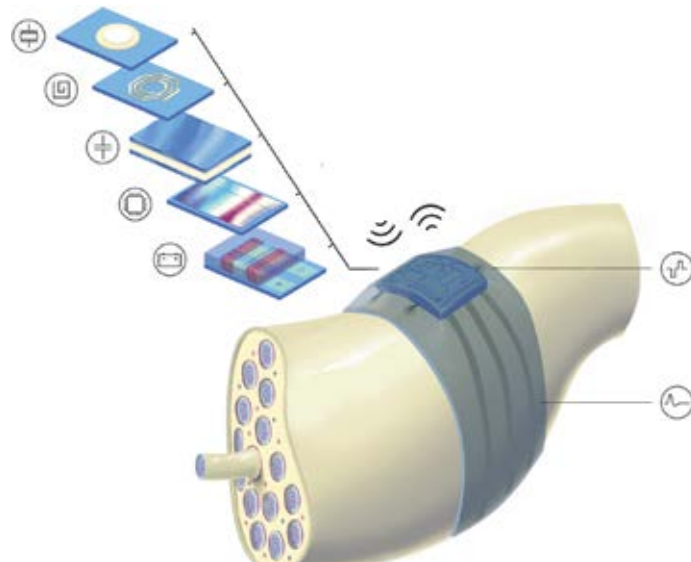

**Figure 1.** An artistic impression and systematic breakdown of a flexible implant that is envisioned for bioelectronic medicine. Image adopted from [1].

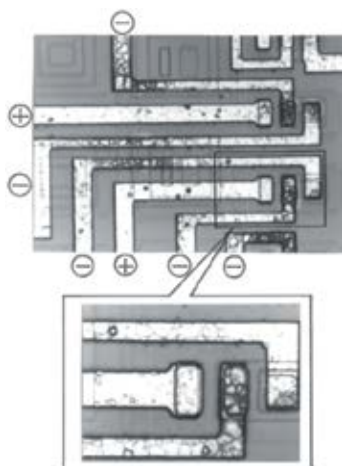

**Figure 2.** Corrosion of aluminium metal tracks in the presence of an electric field.<sup>[7]</sup>

### A tight casing

Principally, the durability of electronic circuits, either discrete or integrated, is greatly reduced when exposed to moist ionic environments. Common failure mechanisms of electronics when exposed to ionic water are: corrosion of metal traces leading to open circuits, high-ohmic shorts between neighboring tracks and electrochemical migration (ECM) between two neighboring tracks that could eventually lead to a low-ohmic short (Fig. 2). In all these failure mechanisms, a narrower spacing between metal traces will increase the probability of failure. For this matter,

conventional implants have relied on a hard titanium box for protecting the electronics inside. Titanium (Ti) is a hard and biocompatible metal with high durability against corrosion that can guarantee a hermetic or 'air-tight' environment for decades within the body. Fig. 3 shows a conventional implant where the Ti-casing is used to protect the electronics and battery.

Driven by the need for more functionality and leveraging the advances offered by semiconductor technologies, over the past years, many implants have adopted Application-Specific Integrated Circuits

(ASIC) for implementing their main functionality. The more compact structure of an ASIC, however, necessitates even more protection against water and ions. Fortunately, the rigid Ti-casing could still guarantee the required hermetic sealing for protecting ASICs.

The conventional packaging solution, however, may no longer meet the requirements of the devices envisioned for bioelectronic medicine, as these devices are foreseen to be smaller, lighter and flexible. This unmet need has prompted various research groups into investigating different thin and flexible solutions that can have a high durability within the body. Polymeric encapsulation, for example, is a promising candidate<sup>[2-3]</sup>. Fig. 4 shows a polymer-encapsulated stimulator, flexible enough to be mounted on a nerve<sup>[4]</sup>.

### Penetrating polymeric encapsulation

Polymeric encapsulation can result in flexible, light-weight and miniaturized devices. The main drawback, however, is the eventual water penetration through the polymer layer, jeopardizing the durability of the device<sup>[2]</sup>. Multi-layer stacking of polymers and inorganic thin-film layers has recently been proposed as a mitigation for this problem<sup>[3]</sup>. Nevertheless, to investigate the durability and reliability of these layers in wet conditions, long-term passive and active (with an electrical field) experiments are needed<sup>[2-3]</sup>.

According to previous research<sup>[2]</sup>, one main failure mode for polymer encap-

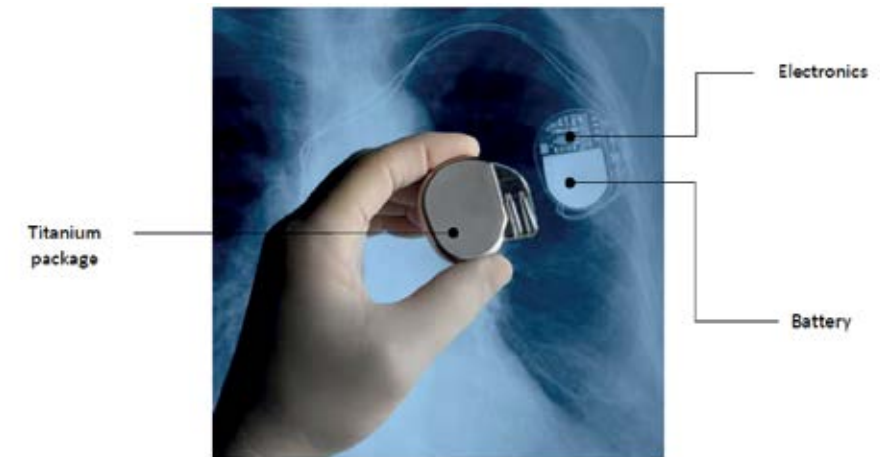

Figure 3. Conventional Ti packaging used for implants.<sup>[6]</sup>

sulated ASICs will start with the delamination of the polymer from the ASIC surface. Consequently, the delaminated region will allow water condensation on the chip surface. Normally in ASIC fabrication, a passivation layer is deposited at the last stages to protect the chip against moisture and ions. Conventional passivation stacks typically consist of SiO<sub>2</sub> and Si<sub>3</sub>N<sub>4</sub>, deposited at around 400°C with a plasma-enhanced chemical vapor deposition process, resulting in a low-density layer. These layers can withstand water vapor levels that are typical for dry conditions, however they are not meant to protect in wet environments like the human body. Previous studies on passivation layers have shown that such layers could go through a chemical corrosion process when exposed to water<sup>[5]</sup>. Investigations by Osenbach<sup>[6]</sup> also revealed that high electric fields could initiate a corrosion process for these passivation layers; thus suggesting that the circuit and system design could also

affect the overall coating durability.

### Finding durable coatings

Within the Bioelectronics group at TU Delft, we have started investigating the durability of various coating layers, with the focus on polymers as the main packaging solution. The most important objectives for our research are:

- I. Investigating the failure modes and their corresponding time points when applying different electric fields to polymer-encapsulated ASICs in soak environments.
- II. Investigating alternative circuit and system designs that could increase the durability of the encapsulated ASICs in soak conditions.

Basically, our approach is not just to study the durability of thin coating layers in soak conditions, but to also investigate the effect of different electric fields and operation modes on the coating durability. By this way, new guidelines could be derived for the ASIC design that could potentially increase the overall lifetime of the device.

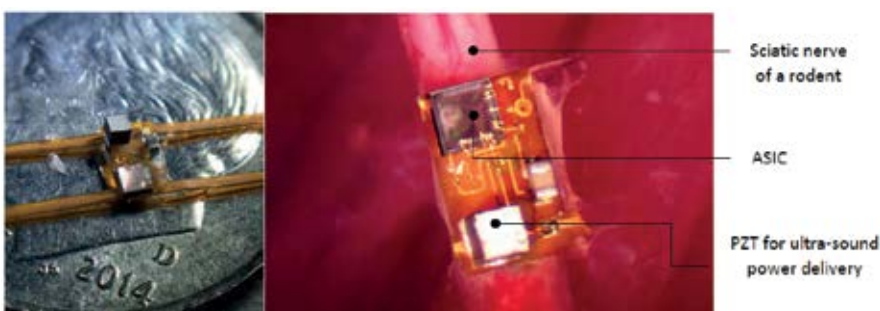
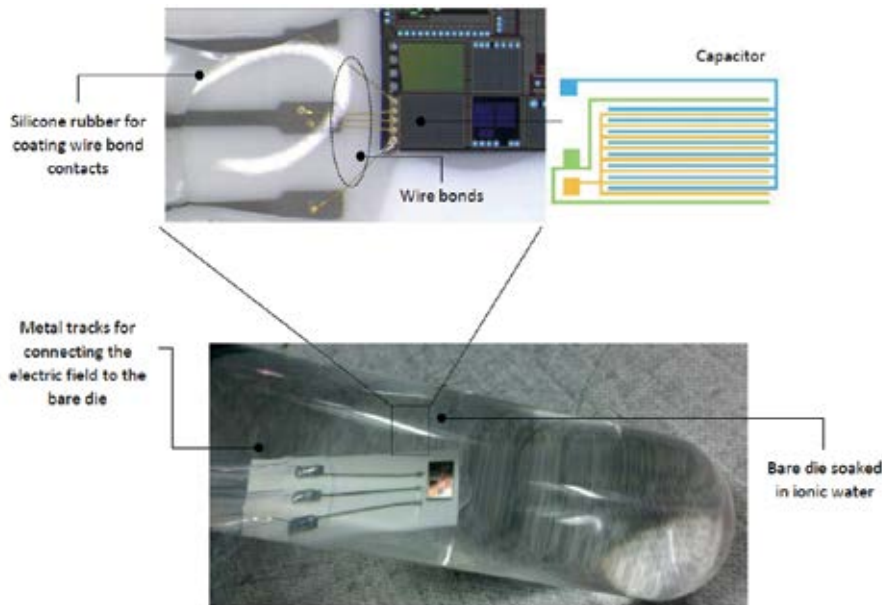

Figure 4. Polymer encapsulated ultrasonic stimulator.<sup>[4]</sup>



**Figure 5.** Bare die soaked in ionic water to investigate the durability of the passivation layer when subjected to an electric field.

The durability of the ASIC in a moist environment is greatly determined by the passivation layers. Therefore, knowing their level of durability and lifetime is of great importance. For this purpose, various structures have been designed and fabricated in two standard CMOS technology nodes. The goal is to investigate the durability of the passivation layers in soak environments with the presence of an electric field (first research objective).

Therefore, only the wire-bond area has been coated with silicone rubber and the remainder of the chip is exposed. Fig. 5, shows, as an example, a capacitor structure that will be used to evaluate the durability of the chip passivation layer. Changes in the capacitance over time would show possible layer degradation or water and ion ingress. For deriving the capacitive values, Electrochemical Impedance Spectroscopy (EIS) is used.

By fitting and modeling the EIS results, changes in the capacitance value can be tracked over time.

To realize the second objective of this research, later, more complex structures and circuits will be designed by incorporating the learnings from the first experiments. The structures will then be tested with the aim of deriving guidelines that could potentially increase the durability of the ASIC in soak conditions.

### Outlook

Bioelectronic medicine is a new and growing field, with the potential of revolutionizing healthcare. The path to realizing this, however, will be even more interesting with great technological breakthroughs. For sure, novel materials and packaging solutions will arise that could meet the needs of this field. However, this shift will not only require new protecting layers. Innovations in circuit and system design are also necessary, so that it could maintain the durability of protective layers, and thereby, the overall device.



- [1] V. Giagka and W. Serdijn, Realizing flexible bioelectronic medicines for accessing the peripheral nerves – technology considerations, *Bioelectronic Medicine*, vol. 4, no. 8, Jun. 2018, <https://doi.org/10.1186/s42234-018-0010-y>
- [2] A. Vanhoestenbergh, N. Donaldson, Corrosion of silicon integrated circuits and lifetime predictions in implantable electronic devices, *J Neural Eng*, 2013, 10(3):1002–1015
- [3] M. O. de Beeck, K. Qian, P. Fiorini, K. Malachowski, and C. Van Hoof, Design and characterization of a biocompatible packaging concept for implantable electronic devices, *J. Microelectron. Electron. Packag.*, 2012, vol. 9, no. 1, pp. 43–50.
- [4] B. C. Johnson, et al., StimDust: A 6.5mm<sup>3</sup>, wireless ultrasonic peripheral nerve stimulator with 82% peak chip efficiency, *IEEE Custom Integrated Circuits Conference (CICC)*, April 2018.
- [5] S. K. Kang, H. Suk-Won, C. Huanyu, Y. Sooyoun, K. Bong Hoon, K. Jae-Hwan, H. Yonggang and J. A. Rogers., Dissolution behaviors and applications of silicon oxides and nitrides in transient electronics, *Advanced Functional Materials* 24, 2014, no. 28, 4427–4434.
- [6] J. W. Osenbach, Water-induced corrosion of materials used for semiconductor passivation, *J. Electrochem*, 1993, Soc. 140 3667–75
- [7] [https://industrial.panasonic.com/content/data/SC/PDF/ww\\_aboutus\\_reliability\\_t04007be-3.pdf](https://industrial.panasonic.com/content/data/SC/PDF/ww_aboutus_reliability_t04007be-3.pdf)
- [8] [www.cosmomagazine.com](http://www.cosmomagazine.com)



# Lightning protection of power systems

## How to protect power systems from severe external disturbances

*Dr.Ir. Marjan Popov*

Power systems are continuously exposed to severe disturbances of different nature, which may seriously affect their normal operation and exploitation. All disturbances can be classified into two major groups; internal and external disturbances. Internal disturbances result from the power system itself. They occur during planned activities performed by utility operators (regular opening/closing line operation or other reparation matters). In this case, we talk about switching contingencies upon which the system undergoes a transient period to achieve a new steady state position. Other disturbances are unpredictable, for instance, the occurrence of fault currents, different transient phenomena that result from some line disconnection due to relay maloperations. The consequences could be resonances or harmonic's impact from a temporary or permanent nature. Since future power systems will also make use of different ICT technologies, a new type of disturbances are cyber-attacks on the electrical power systems. Other external disturbances are various physical contacts between the power system components and its environment, such as lightning, which is one of the most severe disturbances.

### Lightning protection essentials

One of the most severe major external disturbance is the lightning, and power system and components are vulnerable to this disturbance. There are many cases of failed transformers because of lightning. A failed transformer may cause severe outage and loss of electricity for a longer period of time. Besides, lightning results in high overvoltages causing breakdown of the high voltage insulator that in some case may end up with a single phase fault current.

Since the power systems operate with a very high reliability and security of supply, it needs to be continuously monitored, controlled and protected. The complexity of the power system operation is the reason for the large number of phenomena that may affect its normal operation. Therefore, today we talk about a large scale of protection measures that synchronously fulfil their tasks in order to have secure power system operation at all times.

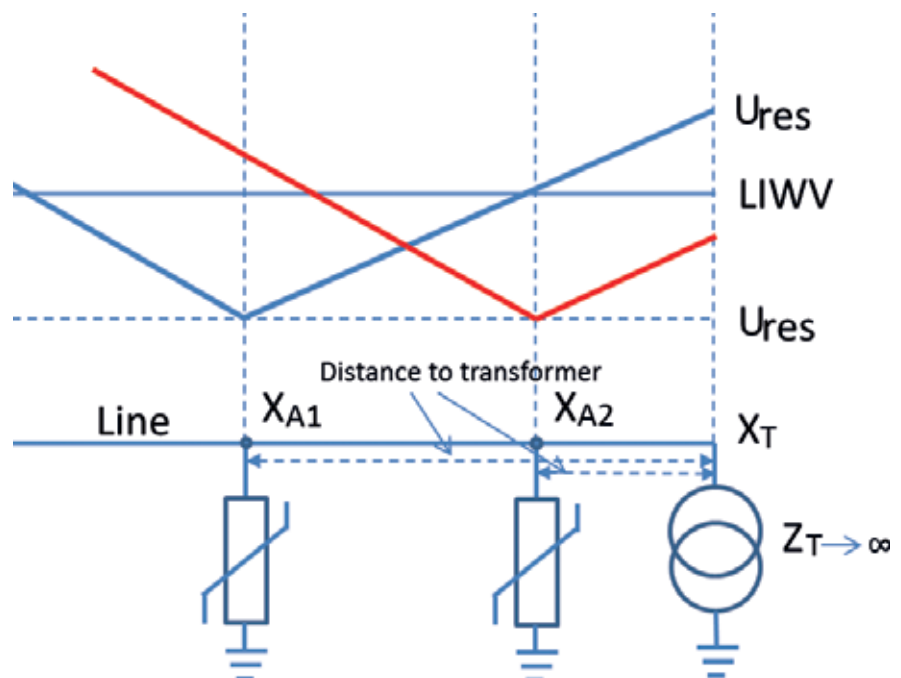

**Figure 1.** An illustration of the effect of the location of the surge arrester from the protected object.

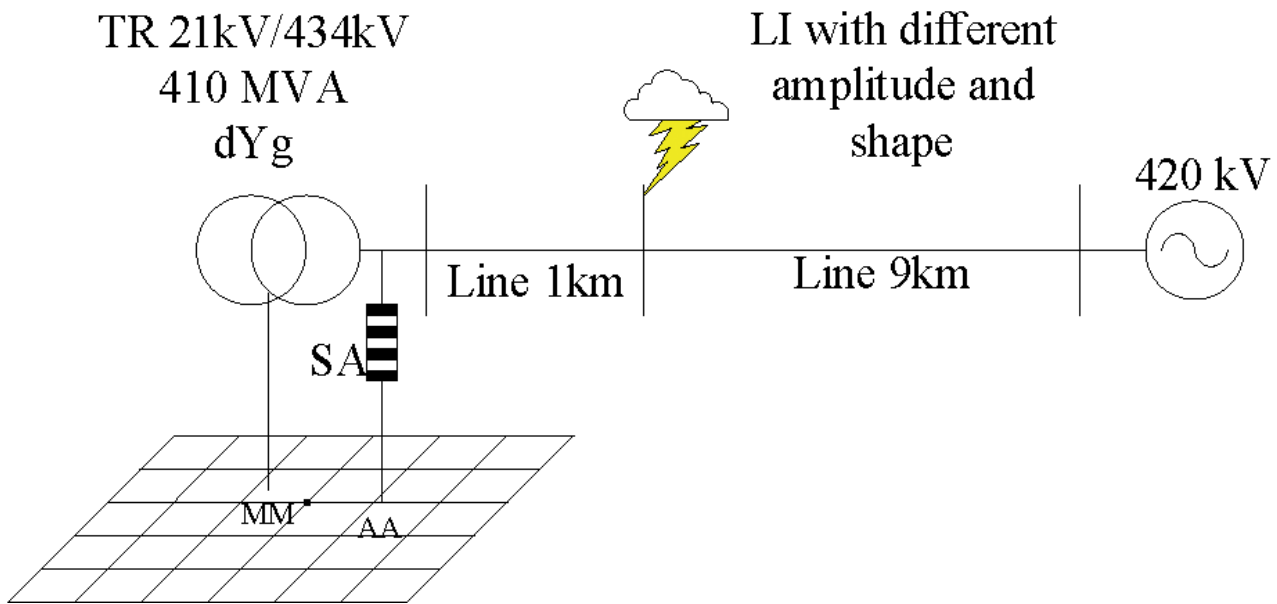

**Figure 2.** An illustration of a simulated system is shown. All components are modelled within a broad frequency range including the grounding system. The lighting occurs at a distance of 1 km from the substation.

### Lightning arresters

Lightning protection deals with the protection of power systems against lightning overvoltages and currents that result from high lightning currents. Transmission lines occupy a large space of an existing power system and, depending on climate conditions, can be frequently exposed to lightning strikes. How often the exposure will occur, is determined by the so-called Keraunic level. According to the IEEE 998-1996 standard[1], the Keraunic level is defined as the average annual number of thunderstorm days or hours for a given locality.

Lightning protection is realized by making use of lightning arresters, which are normally installed as close as possible to the protected object (transformer/cable/substation). The lightning arrester is defined by its protection level, that denotes the voltage value that cannot be trespassed for a particular lightning current with predetermined front wave and amplitude. The values are normally determined for an ideal grounding. However, good grounding for power

frequency voltages and currents does not also mean good grounding for lightning voltages. For power frequencies, the grounding system behaves as a resistance. However, for hundreds of kilohertz up to megahertz oscillations, the capacitances and inductances as well as the skin-effect play an important role and cannot be neglected. This is an important fact that explains why high frequency grounding cannot be ignored. Increased grounding impedance during lightning is the key reason why the voltage at lightning arresters can be higher than that defined in the catalogue data or standards. On the other hand, the insulation strength of the protected device, transformer or cable is defined by its Basic Insulation Level (BIL) (or also known as Lightning Impulse Withstand Voltage (LIWV)).

### Analysis of the system

Based on the above discussion, the correct analysis of lightning protection requires accurate system modelling within a broad frequency range by using an accurate representation of the grounding system. Another important fact is the length between the transformer

terminal and the arrester. After the wave reaches the arrester, one part is reflected, and another part is refracted. The refracted wave proceeds towards the transformer and can be reflected and refracted several times between the transformer and arrester respectively. As the arrester does not allow a higher voltage than its protective level, it is obvious that the closer the arrester is to the transformer, the lower the transformer overvoltage is.

Figure 1 illustrates the effect of the distance between the arrester XA1 and the transformer XT. When the distance is long, the final scenario after travelling through wave reflections, results in a higher voltage at the transformer terminals than in the case when the distance is short. The surge arrester can limit the voltage up to its protected level. In the worst case scenario, the transformer voltage may rise above its BIL value. As the transformer characteristic impedance is much higher than that of the line, the voltage can be doubled.

In Figure 3, the results of the detailed analysis are shown. It can be seen that

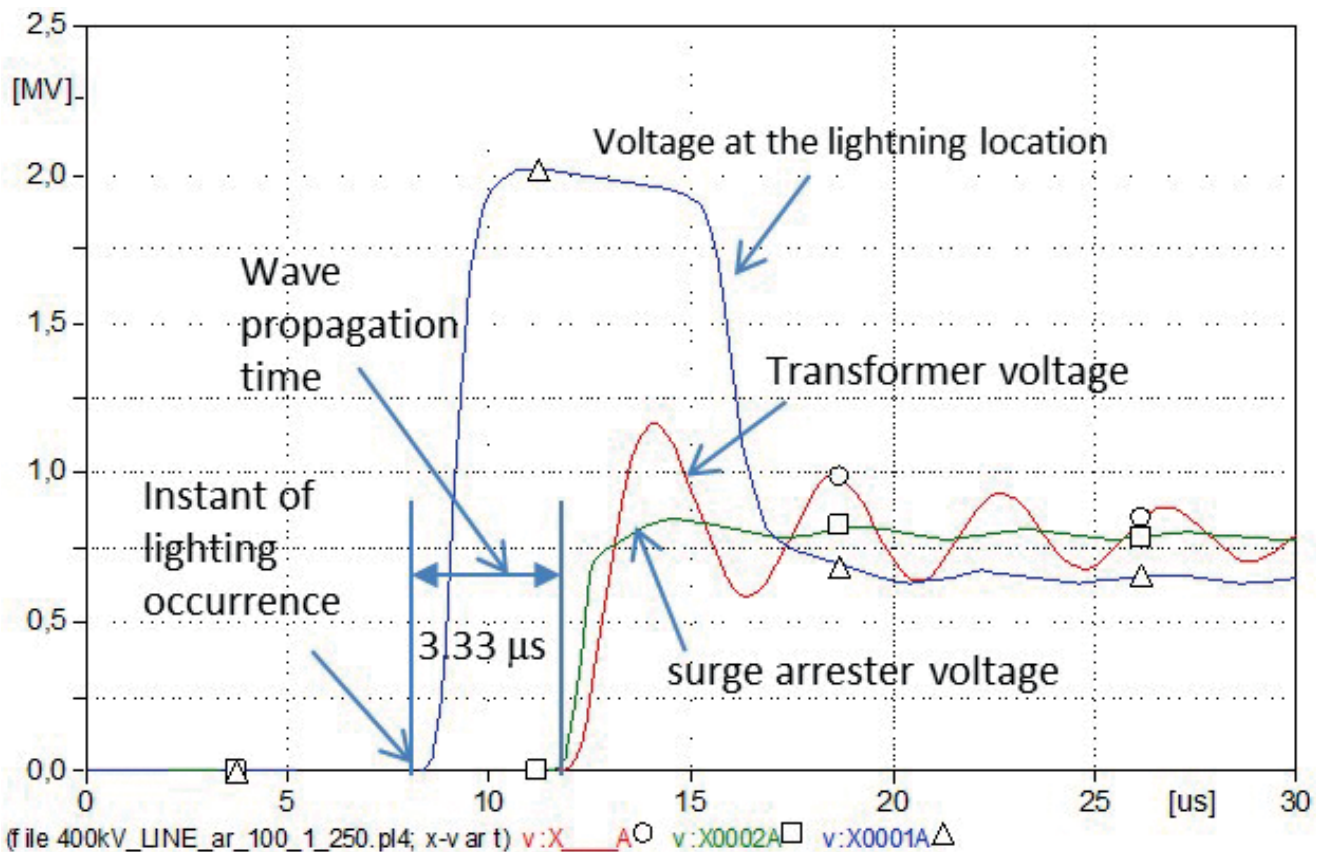

**Figure 3.** Voltage response at different location for a lightning impulse 1,2/50us, 10 kA

when lightning occurs, the voltage promptly rises to a very high value of nearly 2 MV. This voltage wave travels towards the substation with the speed of light and arrives there within 3.3  $\mu$ s. The surge arrester successfully limits the voltage to a particular value.

The refracted voltage wave reflects from the transformer and is higher than the surge arrester voltage because of two reasons. The first reason is the effect described in Figure 1, while the second reason is the grounding effect. The surge arrester is not ideally grounded, as

the grounding impedance varies within time and has a significant influence in the first several microseconds. Hence, it can be expected that the arrester protection level is above the arrester specification value. Thus, the transformer may be exposed to a higher value than its BIL value. More about the effects of the grounding can be found in [2].

This article addresses important features concerning lightning protection studies. Even though the insulation levels and protection levels of the components and surge arresters respectively

are well defined and determined, the grounding effects depend on the type as well as the construction of the grounding system, which can vary significantly for higher frequencies. The grounding at 50 Hz is designed based on the safety condition values for the personnel in the vicinity of the substation; step and touch voltage. However, a good grounding at 50 Hz does not necessarily mean a good grounding for high frequency transient oscillations, and it is subjected to rigorous analysis and complicated computation strategy.



- [1] IEEE Guide for Direct Lightning Stroke Shielding of Substations," in IEEE Std 998-1996 , vol., no., pp.1-176, 15 Feb. 1996
- [2] M. Popov, L. Grcev, H.K.Hoidalén, B. Gustavsen and V. Terzija: Investigation of the Overvoltage and Fast Transient Phenomena on Transformer Terminals by Taking into Account the Grounding Effects, *IEEE Transactions On Industry Applications*, Vol. 51, No. 6, November/December 2015, pp. 5218-5227.

# Forze

## Hydrogen Electric Racing Team Delft

*Koen Rodewijk*

**“Tell us everything you want to tell about your car, your experiences as a full-time engineer and your work as an electrical engineer.” That was the question I got from the Maxwell committee. A difficult task, since there is a lot to talk about, yet I gladly accepted. So, in the following article, I will share my experiences as full-time electrical engineer at Forze and shed some light on our embedded system and the startup sequence. In the end, you’ll know what Forze is all about!**

### What is Forze?

Forze is the Hydrogen Racing Dreamteam of the TU Delft. The goal of the team is to promote hydrogen as a viable fuel in sustainable mobility, by making a competing hydrogen electric race car – the only student team in the world! Last August we were the first in the world to finish a race in a hydrogen electric race car against traditional fossil fuel powered race cars. This year our goal is to win the same races we participated in last year, while also starting the preliminary design of our next car; the Forze IX.

### Full-time electronics

Before I started full-time, I already had experience as a part-time engineer at Forze. Thus, I thought I was already quite prepared. However, being a full-time engineer means much more than designing and producing the electronics in the car; that is what I mainly did in my part-time year. Doing the electronics full-time, means managing our part-time electrical engineers, collaborating with companies, being able to thrive in a team and speaking at events. All of which is of course very interesting and fun to learn, yet it also comes with some big responsibilities. Deadlines, reports and design decisions take on a whole new level of importance when being in charge of all the electronics in a very expensive and important car. Dealing with this takes some getting used to, and more importantly, experience. Luckily, the old team members are always very enthusiastic and willing to help.

### Electronics at Forze

Our electronics is the result of more than 6 years of development, troubleshooting and iterations. It can be genuinely said that our car has the most complex electronics of every machine in the Dreamhall. The complete system is of course too complex to explain in this article, yet the system can generally be put into three categories: the powertrain, the embedded system and the power distribution. The powertrain is responsible for delivering the energy from our fuel cell to the electromotors, via our supercapacitors (also called our ‘buffer’). The power distribution unit ensures that all the components have the correct power inputs, in a safe and controlled manner. Lastly, the embedded system is responsible for connecting and controlling over 500 sensors and 200 actuators in the car. Each of these subsystems are completely designed and produced by the team members ourselves.

### The Dashboard node

The embedded system might be the most interesting to talk about, so we will dive a little deeper into that category. Our embedded system consists out of 9 nodes. Each node is responsible for its own part of the car and is interesting in its own way. Here, we’ll focus on the Dashboard node, which interfaces the entire dashboard to the rest of the system and houses the master FSM as well. The dashboard consists of the steering wheel, which houses a lot of buttons and the main screen, as well as the overhead dashboard, which controls the advanced settings we only use for testing. The master FSM determines the state of the whole car.

The car can be in a total of 30 states, yet most states are used for error-handling and testing. The most important ones include Low Voltage On, High Voltage On, Pressurize and Fuel Cell On.



When we do a fuel cell start-up, we run through these states respectively. When we power on the car, the default state is Low Voltage On. In this state, all the nodes and low voltage actuators (mostly pumps) have power. Furthermore, we can read out all the sensors and control most actuators.

After the power on, we need to close our manual disconnect to be able to connect our buffer to the high voltage bus. Then, we can move on to the next state: High Voltage On. The embedded system closes all the necessary contactors and monitors all the vital voltages and currents. When something is wrong, it will be detected quickly; an error will appear on the screen and the necessary actions will take place.

Once we are in the High Voltage On-state, we are able to drive the car on our buffer for a limited amount of time. We need to go to the Fuel Cell On-state to actually drive the car on hydrogen. However, to reach this state, the system needs to be pressurized first by going to



*Figure 1. Fitting the steering wheel in the cockpit*

the Pressurize-state. After the pressurizing has been completed, we can finally power on the fuel cell and race!

#### **A great experience**

Quite a procedure, right? You might have noticed that working in a Dreamteam, as well as designing a race car, takes more thought than you probably initially think. Nevertheless, if done

correctly, it can be an enormously fun and educational experience!

If you have become interested in Forze after reading this article, you can of course always visit us to see the car for yourself. Also, you can stay up-to-date by following us on social media under the name Forze Delft. Hope to see you soon!

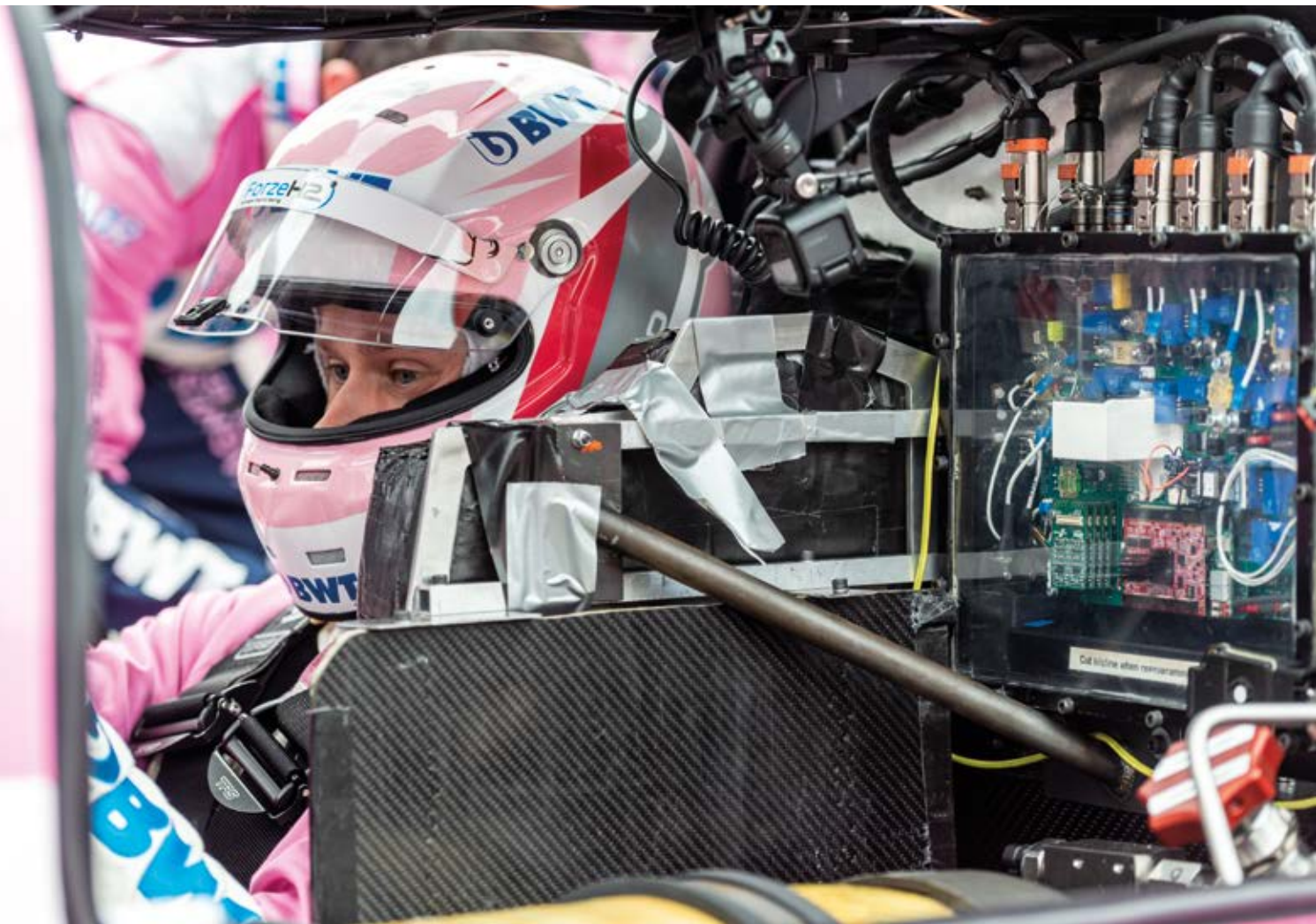

# Exploring the past with future radio telescopes

## When Big Bang meets Big Data

*Dr. Ir. Shahrzad Naghibzadeh and Prof. Dr. Ir. Alle-Jan van der Veen*

**It all started with the Big Bang! After the explosion about 13.8 billion years ago, in a fraction of a second, the universe started to expand and gradually cool down to form the first particles. After about 300,000 years, the first atoms, mainly hydrogen and helium, were formed. In the subsequent 6 to 7 hundred million years, galaxies and quasars began to form in an otherwise dark universe. About a billion years ago, the first stars began to shine and the cosmic dawn started. Fast forward to today, and astronomers and engineers work hand-in-hand to build powerful telescopes that look back in time, to unravel the history of the universe with increasingly more observational evidence. However, the increasing volumes of data poses many processing challenges. We aim to address these challenges by developing highly efficient imaging algorithms.**

In observational astronomy, electromagnetic waves originating from cosmic sources, impinging on the earth, are measured with the help of telescopes. Astronomers study the cosmic objects and phenomena based on these measurements. While optical telescopes can only observe the light emitted from the stars, highly sensitive radio telescopes can look back in time. This is done by observing weak radio emissions originating from the hydrogen line and ionized gases, even before the first stars were created. These observations provide us with valuable evidence to study the creation of the universe and formations of the stars. Figure 1 shows the different views of the Centaurus A galaxy at radio versus optical frequencies. Clearly, radio frequencies provide an entirely independent view of the galaxy. During the last century, radio astronomy has been vastly advancing. Important discoveries on the formation of various celestial objects such as pulsars, neutron stars, black holes, radio galaxies and quasars are the result of radio astronomical observations.

To study celestial objects and the astrophysical processes that are responsible for their radio emissions, images must



**Figure 1.** From left to right: Centaurus A galaxy at optical frequencies, at radio frequencies and superposition of the two views. (Image credit: NASA and ESA)

be formed. Proper astrophysical interpretations require the image to have a high resolution and dynamic range. Radio waves are about 1 million times longer than optical waves. Therefore, to attain a similar resolution as optical telescopes, very large radio telescopes are required. Furthermore, radio telescopes must be able to detect incredibly faint signals from very distant objects, i.e. look back in time. Consequently, sensitivity is a defining factor for radio telescopes. Sensitivity of a radio telescope is proportional to its total collecting area. Hence, to make high-resolution and high dynamic range images of the radio sky, radio telescopes with large apertures and large collecting areas are required. To make the building of extremely large telescopes more practical, a large telescope is synthesized by com-

binning the received signals from an array of radio telescopes with smaller apertures as shown in Figure 2. Given the noisy, incomplete and indirect observations, the radio interferometric imaging problem is to invert the measurement process in such a way that an estimate of the intensity of the measured celestial sources are attained. The essence of the inversion problem consists of a (non-uniform) multidimensional inverse Fourier transform, between the radio telescope measurement space and the image space, followed by a deconvolution to correct for the (non-uniform) sampling effects. Similar problems occur very often in computational imaging, e.g. MRI, ultrasound echoscopy and radar image formation.

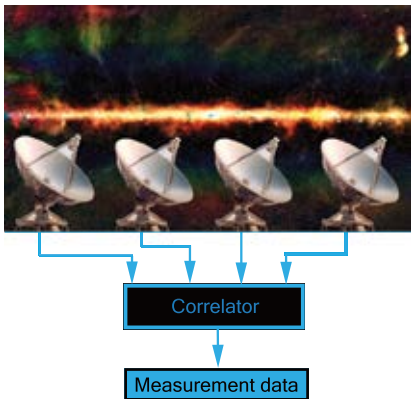

**Figure 2.** Interferometry

### Next generation radio telescopes

To unravel the origins of the universe, engineers are building the largest science facility ever built by mankind, the Square Kilometre Array (SKA). The SKA is designed to satisfy highly ambitious scientific goals, by generating very high resolution and high fidelity images. To achieve the high-resolution requirements, the SKA will be composed of a large aperture consisting of millions of coherently connected antennas extended over an area of about 3000 kilometres. Furthermore, the SKA has a large total collecting area of about one square kilometre to increase sensitivity about two orders of magnitude relative to the current radio telescopes. The phase-one SKA (SKA1) design has been largely completed and its construction is expected to start in 2019, while the complete instrument should be ready by 2023 (provided funding becomes available). Some of the antennas constituting the SKA1 are currently under construction in the designated sites (radio-quiet zones) in Western Australia and South Africa. One of the currently operational prototype stations of the SKA is shown in Figure 3.

Nevertheless, the introduction of the next generation radio telescopes, and in particular the SKA, are bringing about many new challenges. Image formation from measurement data has become increasingly more difficult. This is due to three reasons. Firstly, the amount of measurement data is enormous: the raw

data is more than 260 terabytes per second, and a single measurement session lasts hours to weeks. This data volume is beyond the available storage facilities and requires quasi-real-time processing and reduction. Secondly, to make images in the current way, supercomputers are needed that can handle more than 350 peta operations per second (peta =  $10^{15}$ ; about one million PCs). Lastly, the increased sensitivity, resolution and sky coverage, as well as the ambitious science cases of the new instruments, are beyond the capability of the current imaging methods and ask for highly accurate new imaging algorithms.

### Our mission

In a shared project called DOME, ASTRON and IBM have been involved in developing a computing system that is expected to become the IT-backbone of the SKA. During the past 4 years, we have been involved in DOME to help overcome the imaging hurdles of the SKA by developing novel imaging algorithms. Our aim has been to create images that are good enough for the SKA, yet certainly do not require more computing power than current techniques do. Furthermore, the imaging algorithms have to be feasible at the scales



(a)



(b)

**Figure 3.** (a) A full station of 256 low-frequency antennas at the Murchison Radio-astronomy Observatory (MRO) in outback Western Australia, (b) top view (images courtesy of [www.skatelescope.org](http://www.skatelescope.org))

required by the SKA. A major issue is that the imaging problem is numerically very sensitive; a small disruption in the data could yield very different results. To solve this issue, prior knowledge (i.e. what the sky should look like), has to be inputted to the problem. Until now, this prior knowledge consisted of modelling the sky as a collection of point sources. However, at the higher sensitivities offered by the SKA, radio emissions also appear as distributed radiation from diffuse media. In order to achieve the sensitivity of SKA, different and more general prior knowledge is required.

We have introduced a technique to efficiently model prior knowledge and to introduce it into the imaging problem. Moreover, we have developed numerical techniques to solve the problem efficiently. The proposed algorithm is named PRIFIRA [3]. The first results on small-scale test data are promising (see Figure 4): the proposed algorithm is faster than the algorithms that are currently in use, namely the methods CLEAN [2] and SARA [1]. PRIFIRA also seems to be better than the high-resolution algorithms that others recently have proposed. The next step is to test this algorithm on large-scale astronomical data and to check whether astronomers find the resulting images reliable.

To enable the efficient use of large resources, algorithms are required to be highly scalable. Luckily, modern convex optimization problems can be formulated in a distributed fashion. Leveraging the distributed algorithmic structures, both the data and the image can be split into an arbitrary number of blocks which can be handled in parallel by splitting over multiple processors. We have devised highly scalable algorithmic structures for radio interferometric imaging by applying distrib-

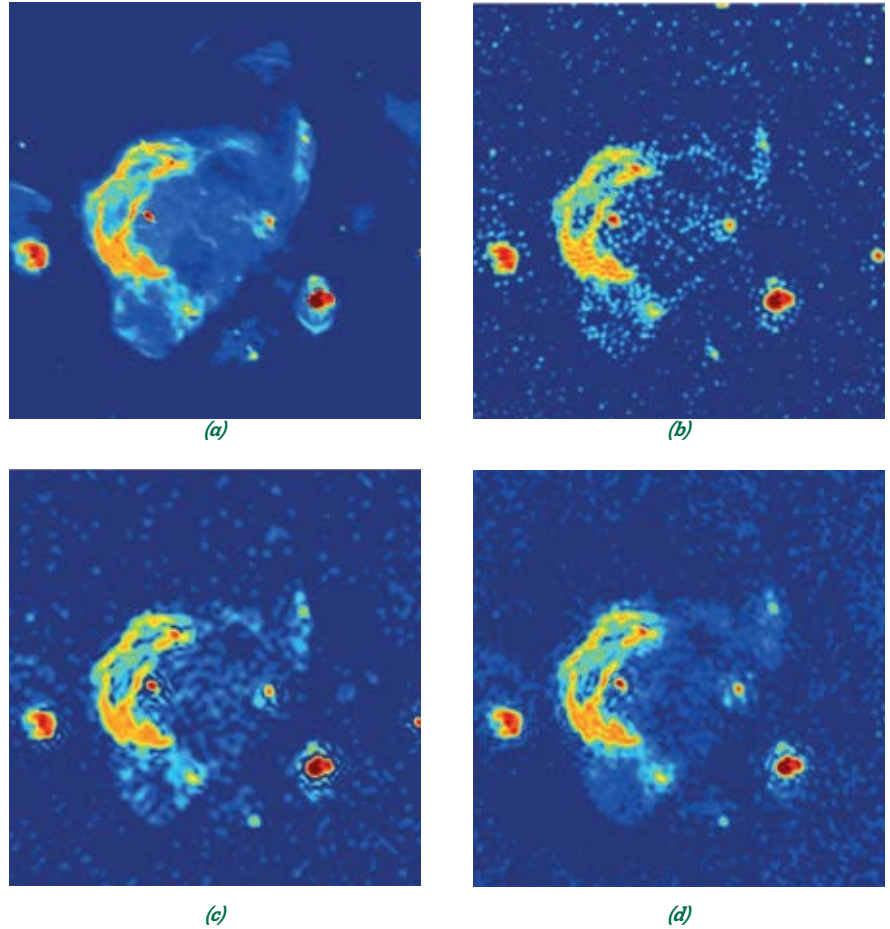

**Figure 4.** (a) Original image (the measurements are simulated by transforming this to the measurement domain, by sparsely sampling based on telescope locations which are further distorted by noise.), (b) Current standard algorithm (CLEAN), 1 min computation time, (c) current best algorithm (SARA), 6 min, (d) Proposed PRIFIRA algorithm, 35 sec

uted processing in the image and data domain. We do so by dividing the large images over source occupancy regions and evenly distributing the telescope data over blocks. We have concluded, based on realistic simulations, that this scheme provides considerable memory and computational savings.

### Conclusions

All in all, the SKA is one of the most ambitious projects where engineering and scientific expertise come together to

make one of the long-standing human dreams come true: to explore the origin of the universe. Since the start of the project, many of the engineering obstacles have been overcome and valuable research has been conducted, whose impact goes beyond the SKA alone. For the instrument to become fully operational, there are still a lot of engineering efforts required to overcome the foreseen and unforeseen challenges.



- [1] Rafael E Carrillo, JD McEwen, and Yves Wiaux. Sparsity averaging reweighted analysis (SARA): a novel algorithm for radio-interferometric imaging. *Monthly Notices of the Royal Astronomical Society*, 426(2):1223–1234, 2012.
- [2] JA Högbom. Aperture synthesis with a non-regular distribution of interferometer baselines. *Astronomy and Astrophysics Supplement Series*, 15:417, 1974.
- [3] Shahrzad Naghibzadeh and Alle-Jan van der Veen. PRIFIRA: General regularization using prior-conditioning for fast radio interferometric imaging. *Monthly Notices of the Royal Astronomical Society*, 2018.



# Electromagnetic Compatibility aspects of cabling

Dr. Alexander P.J. van Deursen (TU/e) and Dr. D. Beltram (ITER Organization)

ITER (Latin for 'the way') is a megaproject in which the European Union, India, Japan, China, Russia, South Korea, and the United States aim to demonstrate the scientific and technological feasibility of nuclear fusion energy by magnetic confinement. The goal is: 500 MW generated power for an energy input of 50 MW into the plasma ( $Q = 10$ ). ITER will be the first reactor that generates more fusion power than is needed to heat the plasma. For the purposes of this paper, we will describe ITER very briefly and refer the reader to the ITER website ([www.iter.org](http://www.iter.org)) that is continuously updated to reflect the progress of the work. Many exciting pictures can be found there as well.

## Design of ITER

The initial design for ITER started in the late eighties. The decision to build ITER near the French nuclear facility Cadarache, in the Provence region, was taken in 2005. After preparation of the 0.5 km<sup>2</sup> large site, building construction began in 2015. Commissioning of the reactor is scheduled in 2025, and the actual deuterium-tritium fusion experiments will start in 2035. As foreseen now, the experiments will last for about 20 years.

ITER is huge in all aspects, such as building and vessel size, amount of required superconducting material and number of people involved all over the world, etc. For instance, it is the only facility directly connected to the French 400 kV power grid, as it requires 2 GW of power during operation. A cut-away view of the machine is shown in Fig.1, where the circle in the lower-right corner indicates the human size.

*"ITER is huge in all aspects, including number of people involved all over the world"*

The 5 kilotons stainless-steel vacuum vessel holds the plasma, the diagnostics,

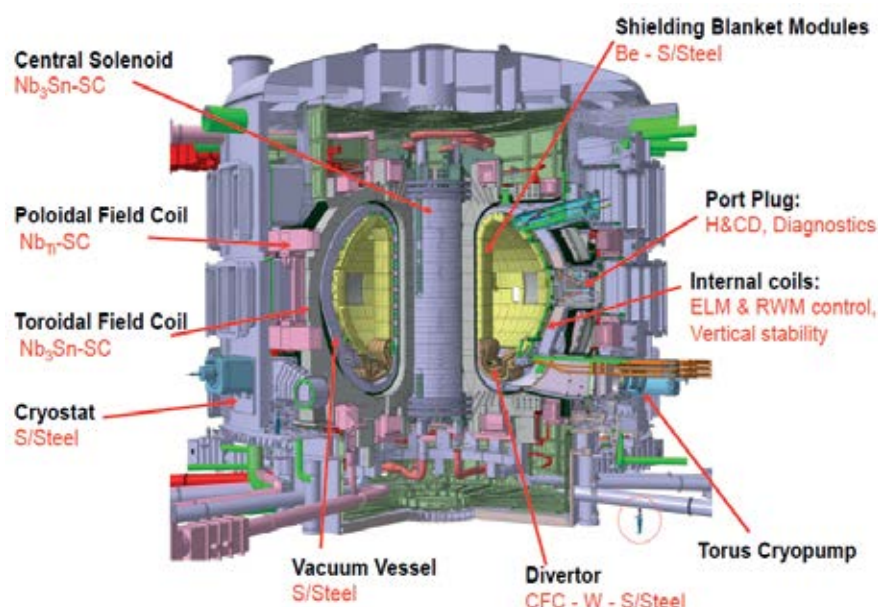

Figure 1. Schematic view of the machine (Courtesy of ITER organization).

and the blanket to shield the magnets from the neutrons generated by the plasma. The vessel is double-walled to allow water cooling. 12 D-shaped toroidal field coils provide a 12 Tesla field to contain the plasma in the torus; their total magnetic energy is about 40 GJ. The central solenoid (13.5 T) is the primary winding of the transformer, which drives the plasma that acts as the secondary single turn winding with 15 MA.

Other magnets steer the position of the plasma inside the vacuum vessel. The vacuum vessel and magnets are surrounded by the 4 kilotons cryostat vessel, with an inside 80 K thermal shield for the superconducting magnets. At 44 positions over the circumference and at three levels, ports allow access to the vacuum vessel e.g. for plasma heating by injection of a neutral particle beam.





*Figure 2. Meshed Bonding Network (© A.P.J. van Deursen)*

### The cabling network

A precision measurement system in the cryostat for temperature, vibration, strain, position etc. has to operate in the presence of large, strong and strongly-varying magnetic fields, near intense high-power microwaves, all the while functioning over several decades without maintenance. It is clear that a large number of cables will run towards and inside the machine, for power, diagnostics, measurements and control. In spite of the extensive size of the machine, space for cabling is often very limited, in particular near the central coil where we face a 5 K super conductor at one side and a 100 MK plasma at a small fraction of a meter distance. All this required a careful study of Electromagnetic Compatibility (EMC) issues, such as cabling, grounding and shielding; a field of research where TU/e professor Van der Laan contributed to over many years.

*“Single point grounding would be unmanageable with the complexity of the ITER installation”*

Earlier tokamaks relied on a philosophy called ‘single point grounding’ where a point, most often chosen under the center of the torus, was chosen as ‘reference’. Such an approach would be unmanageable with the complexity of the ITER installation. We arrived at two different solutions: outside the cryostat a meshed common-bonding network, and a loop-controlled approach inside.

### Using ladders and trays

The meshed bonding network consists of interconnected metal ladders for cables carrying power and strong signals, and trays for cables with smaller, sensitive signals. The ladders and trays are stacked on top of each other, and interconnected over the whole ITER premises. An example is shown in the leftmost photo of Fig. 2, taken recently in September 2018 before the cables were placed. The photo at the right shows partially installed cabling in an electrical room.

The zinc-plated steel mounting of the ladders and trays is heavily built; the Fukushima accident showed the necessity to withstand severe earthquakes. Copper strands provide additional cross-connections. Cable armor



and shields are connected to this ‘parallel earthing conductor’, or PEC as it is called in IEC 61000-5-2. Wherever possible, the tray/ladder structure is bonded to the dense steel concrete reinforcement as well as to grounding structures in the soil. The whole distributed connection to the earth ensures safety against interference, ranging from AC and DC power short-circuit currents to lightning, and local protection against interference caused by rectifiers and switched mode electronics, such as variable frequency drives and uninterruptible power supplies.

*“The peak dissipation is readily comparable to the total day-time electrical energy consumption of the Netherlands”*

### The challenges within the machine

Inside the cryostat, the sensors and cables have to match a completely different environment: from 500 K to 5 K, high vacuum, and strong magnetic fields. In case of an emergency shutdown, the 40

GJ in the toroidal coils has to be evacuated within 7 seconds and dumped in resistances outside of the building. The peak dissipation is readily comparable to the total day-time electrical energy consumption of the Netherlands.

*“It will take several years to see it fully implemented, but it was a pleasure to contribute to this exciting experiment”*

So, we have to take strong rates of change of the magnetic field ( $dB/dt$ ) into account inside the cryostat. However, to our good fortune, there is the thermal shield to fence off 300 K ther-

mal radiation for the superconducting magnets; it is built of several 2 cm thick silver-plated stainless-steel plates. Individual plates are electrically insulated in order to avoid excessive currents and dissipation during shutdown. Still, the plates can serve as local (EMC) protection for the cables, with due attention at the breaks between the plates. In addition, one can use the vacuum vessel for protection. The preferred cable routing over the vessel is indicated in Fig. 3.

All routing inside the cryostat is chosen to minimize magnetic flux variations from the toroidal field, which means that cables run in radial direction to minimize common-mode currents, and that they run over metal surfaces where possible. Another reason to limit the common-mode currents are the large

Lorentz forces, that arise in fields above 10 T with cable lengths over several tens of meters, even for small currents.

### Future implementation

Over a period of three years, we discussed many items on cabling, protection and grounding. It was a challenge to find acceptable and installable solutions with known margins of safety for each case. It will take again several years to see it fully implemented. Nevertheless, for Professor Van der Laan and Dr. Van Deursen it was a pleasure to contribute to this exciting experiment.



Disclaimer: The views and opinions expressed herein do not necessarily reflect those of the ITER Organization.

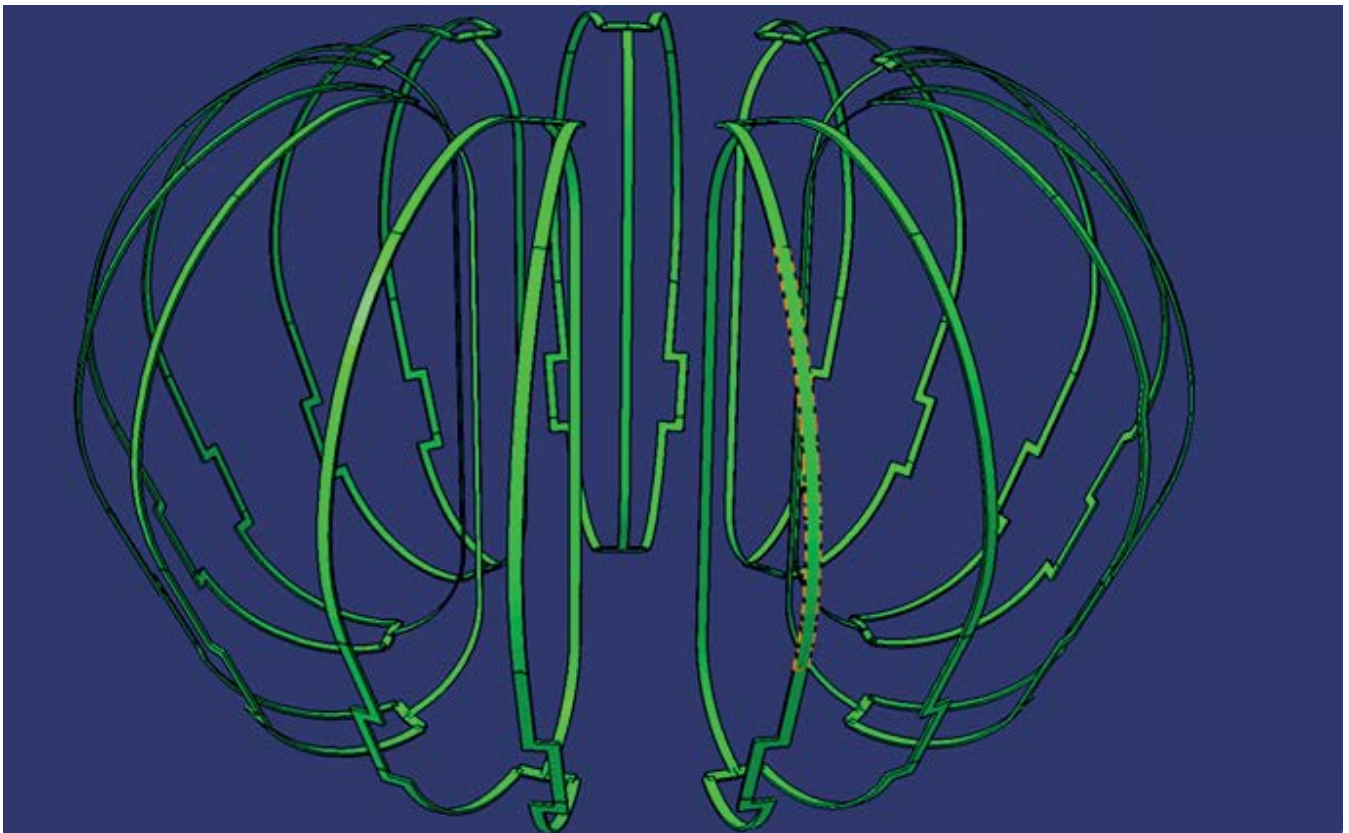

**Figure 3.** The green elements show ‘cable trays’ on the vacuum vessel, in the limited space between the vessel and the thermal shield. (Courtesy of ITER organization).

# Development of a semi-automatic offshore crane

Advertorial

Frank Teunisse

**As a student, I never considered working in the offshore industry, as the only EEMCS-field I associated it with was Electrical Power Engineering. Little did I know about the multidisciplinary high-tech solutions that Allseas develops at its engineering centre in Delft. This article describes my experiences while working in the offshore industry for three years.**

I am Frank Teunisse, an R&D Engineer at Allseas. I got both my BSc in Electrical Engineering and MSc in Embedded Systems at the TU Delft. After working as an IT consultant for two and a half years, I was looking for a job where I could apply my graduation specialisation (Computer Vision) in the field. This led me to Allseas, a leading offshore contractor specialising in pipelay, heavy lift and subsea construction. The company is renowned for transforming bold ideas into state-of-the-art solutions to meet the market's ever changing needs. Our Innovations Department in Delft employs over 200 engineers with a wide variety of backgrounds.

In the three years that I have been working with Allseas, my main project has been the development of a semi-automatic offshore crane. For our pipelay vessels to work continuously for hundreds of kilometres, they require a constant flow of pipe joints (12-m pieces of steel pipe). For this purpose, Allseas uses pipe supply vessels (PSVs) to deliver joints, which are hoisted on board by pipe transfer cranes. During the transfer of pipe joints, which can weigh up to 3.5 t, waves can cause relative motions between the two vessels. Currently, pipe joints are hooked onto the crane manually using slings by so-called riggers, which is a potentially hazardous job.



*Figure 1. The spreader bar picking up a pipe joint*

The goal of our project is to remove the need for riggers on the pipe supply vessel, by realising “unassisted pipe pick-up”. Figure 1 shows this system working in practice; a spreader bar lands on the joint and slides stabbing pins into the pipe ends. I have been working mainly on the camera system that is used to measure the relative motion of the PSV and spreader bar.

This system uses motion capture cameras, in-house developed infrared beacons

(circled on Figure 1) as reference points and an in-house developed photogrammetry algorithm. Photogrammetry is based on the principle that if you look at a point in space from different, known angles, you can calculate the position of that point in space. The beacons consist of three PCBs that generate short, intense pulses of infrared light (1 kW for 150  $\mu$ s), synchronised with the shutter of the motion capture cameras.





*Figure 2. Inside a prototype infrared light*



*Figure 3. Real-size test setup for the camera system with an 8 x 8 m camera frame*

Once we had both the infrared beacons and photogrammetry algorithm working, it was time to put them to the test on a full-scale test setup. Figure 3 shows me controlling the 8 x 8 m camera frame that was built for this purpose at one of our yards.

For unassisted pipe pick-up to work, a motion compensation system is needed. When the spreader bar is in close proximity to the PSV, the pipe transfer tool enters a “follow PSV mode” in which the spreader bar follows the motions of the PSV, and thus remains motionless relative to the moving PSV. In this mode, the crane operator manipulates the

position of the spreader bar relative to the PSV in order to land precisely on the right pipe joint.

To put the developed control algorithms to the test, I was responsible for creating a test-setup that realistically scaled the dynamical behaviour of the system. The test setup used industrial robot arms to simulate the movement of the arms of the crane and the wave motion. Where possible, it used the same industrial hardware as installed in the actual crane.

After the test phase, it was time to install our hardware on Allseas’ pipelay vessel “Solitaire”. In 2017, we travelled

to Freeport, in the Bahamas, where Solitaire was mobilising for a pipelay job in the Gulf of Mexico, to install and commission the system.

We later returned to Solitaire to fine-tune the system and solve minor problems that occurred during offshore tests. In August 2018, I was on board to co-ordinate the preparation of the crane for an upcoming project, where the unassisted pick-up system will be utilised.

☐

*Figure 4. Scale 1:12 test setup for the motion controller*



# Power quality and Sustainable Energy Systems

A Sustainable Energy Technology master thesis

Joanna Christiaanse

In September of this year, I started my thesis for the master Sustainable Energy Technology. Under the guidance of the company HyTEPS, as well as Simon Tindemans from the TU Delft and Sjef Cobben from the TU Eindhoven, I began my work on the influences of commercial sustainable energy technologies on an industry's power quality. In this article, I would like to shortly explain the context of my thesis. First, I will give a short introduction into the company and into the basics of power quality. Then, I will touch upon the goal of my thesis and the tools available to achieve it. Finally, I will wrap up by telling the challenges I have been facing so far and the challenges I will be facing during the rest of my work.

## My experience within the company

HyTEPS<sup>[1]</sup> is a power quality specialist. It is a small company that monitors and analyses power quality in various industries. Once identified, they solve the problem, if any, by providing the necessary equipment. Alternatively, they can verify installations when they do comply to the norm. So far, I have had the opportunity to learn a lot about power quality, as I have been sent to various locations to evaluate and measure the installations. Also, I have already had the pleasure of working directly with the clients that are involved in the project. During my thesis, I have the chance to experience what it is like to be part of a company, as well as to experience working on a project that has an immediate impact on everyday practices.

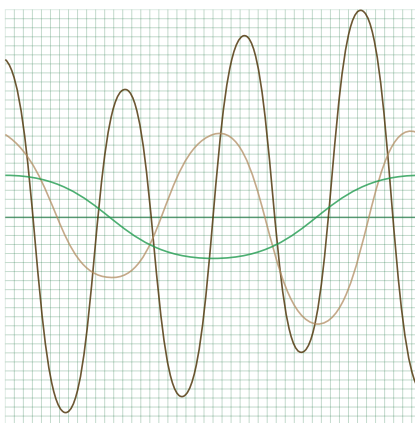

**Figure 1.** Harmonic frequencies are a common cause of low power quality.

## Introduction to power quality

Only recently, the Intergovernmental Panel on Climate Change published their findings in the climate report. It has been stated that human activities are estimated to have caused approximately 1.0 °C of global warming above pre-industrial levels.<sup>[2]</sup> Indeed, climate change as well as the decrease of exhaustive resources are the two main reasons as to why we are investing in the Sustainable Energy Systems (SES). Industries, being big contributors to the total emission of greenhouse gases, are expected to follow.

*“Human activities are estimated to have caused approximately 1.0 °C of global warming”*

However, with the installation of SES, the effects on the power quality must be considered carefully. For example, distributed generation like solar panels are reported to cause high voltage levels when delivering to the grid. The consequences either include the shutting down of the inverters, or in case they do not shut down, damage might even be caused to sensitive equipment. Moreover, there have been reported unbalances while charging electric vehicles,

which cause inefficient use of the available capacity and currents through the neutral. These are all examples of poor power quality.

In power systems, the operation of interconnected electronic equipment is highly dependent on the quality of the available voltage and current, as well as the interaction between these two. This is otherwise known as power quality. Good power quality ensures efficient functioning, safe operation, and longer preservation of the electronic equipment. Today, power quality has become increasingly relevant, due to the higher numbers of sensitive equipment that often generate disturbances themselves as well. This means that industries have become more reliable on the availability of good power quality.<sup>[3]</sup>

## The goal of my thesis

Since prevention is better than curing, the company HyTEPS is in the process of providing ways to predict or identify future effects on the power quality. Through this thesis, a contribution is made that fits their mission. This is achieved by identifying the effects of planned commercial SES. The identification process includes monitoring the power quality of a company, commenting on its current status, evaluating the impact that a SES installation would

have on the system, and finally, clarifying what their new power quality status would be.

In the literature, many have touched upon the analysis of the power quality of SES. However, what makes this project different, is that it focuses on creating a tool that can determine the impact of a SES on various types of networks, using only the measured data of that network. This puts a lot of pressure on the measurements. Moreover, the limits provided by the companies themselves need to be taken into account as well, meaning

that measurements cannot be taken at any possible time or during any possible situation.

*“In the world of Electrical Engineering, you can never assume certain phenomena”*

Thus, one of the biggest challenges lies in achieving the right data at the right time. This is because these results will represent the real world on which my

analysis will be based upon.

In these first few weeks of my thesis, I have learned a lot about power quality and its growing importance in the industry. Therefore, I would like to round off this article with one of the most important lessons I have learned at HyTEPS so far: no matter how much you read or how much you experience, in the world of Electrical Engineering, you can never assume certain phenomena. Measuring is knowing, and it creates a depiction of reality on which we can all agree upon.



**Figure 2.** Performing measurements on-site.

- [1] “HyTEPS uw partner in Power Quality advies en oplossingen”, HyTEPS.nl, 2018. Available: <https://www.hyteps.nl/> [Accessed: Oct. 19, 2018]
- [2] Intergovernmental Panel on Climate Change, “Global Warming of 1.5°C” Intergovernmental Panel on Climate Change, 8-10-2018. Available: <http://www.ipcc.ch/report/sr15/> [Accessed: Oct. 19, 2018]
- [3] J.F.G. Cobben, Power Quality: Problems and Solutions. Arnhem: CO-Education, 2016

# RF energy harvesting for IoT sensors in smart buildings

A bachelor graduation project

*Daniël Kapelle*

Modern day society becomes more and more dependent on an abundance of data. This data can be used to our advantage in many cases. Often this data comes from sensors that measure all sorts of quantities. One can imagine those sensors require a certain amount of power to operate. They could either be plugged into a power outlet, or powered by a battery. This requires the need to either install cables or to replace batteries on a regular basis. This can become a problem if the number of sensors becomes very large or if they are in hard-to-reach places. It would be best if they didn't need either. Although this might sound like magic, it is in fact possible by a concept called RF energy harvesting.

## Bachelor Thesis

The dean of our faculty had proposed a bachelor thesis project to explore the possibilities of such techniques with respect to office environments in so called smart buildings. The goal? Design a device that can perform measurements, e.g. temperature, and connect it to the cloud without using a power supply.

With a total of six students we took on this challenge and started investigating the problem. This started, of course, with finding literature on the status quo regarding this subject. Although a literature study is always a tedious task, it really paid off in the long run.

After ploughing through numerous papers in the IEEE repository and familiarizing ourselves with the problem at

hand, the moment was finally there. It was time to start thinking about a global approach to the problem. Obviously starting from the top and slowly diving deeper into the different parts.

## System overview

The general idea of the project is to gain energy from present RF energy. With the abundance of cell phones, Wi-Fi routers, bluetooth headsets and much more radio communication, electromagnetic energy is always present. We wish to extract some of this energy for our device. One can imagine that the amount of energy that can be extracted is extremely small, so the entire system must be as efficient as possible.

Dictated by the organization of the bachelor thesis programme, we were to

split up in three groups of two. It soon became very clear how we could divide the project in three smaller subsystems to work on in parallel.

Figure 1 shows the global system overview that we decided on. All three will be briefly explained.

## Energy harvesting

The first subsystem is the one that performs the actual harvesting. It consists of an antenna and a matching network to allow maximum power transfer to the next subsystem (conversion and storage).

Bauke and Victor dived into this part and started off with an investigation on what signals were present. Both by means of literature researching and by

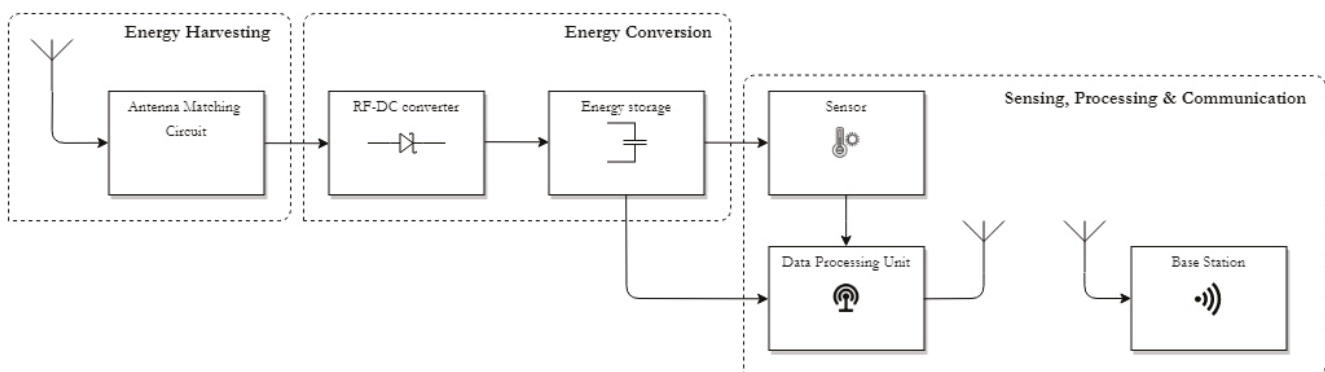

**Figure 1.** System overview showing the three subsystems.



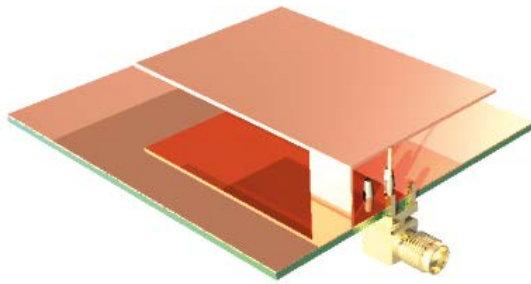

**Figure 2.** Render of the antenna that was later built.

taking a wide band antenna and a spectrum analyzer to see at which frequencies the most energy was present. This led to the decision to harvest around 900MHz which is the band used by GSM.

They then commenced their pursuit for the best antenna. After testing many different antennas and determining their S-parameters, they figured they were no good. That's when they decided to design and build their very own antenna which is shown in figure 2. This one actually surpassed the specs of all the other antennas! They then designed an LC matching network. This proved rather difficult as parasitics play an enormous role at such high frequencies and it's hard to find the right components that can operate at those frequencies.

### Energy conversion

The second subsystem is all about storing the harvested energy. The input is a very small 900MHz signal. This has to be rectified and boosted to a usable voltage level of 3.3V which should then be stored. We chose to use a large capacitor as storage device.

Detmer and Pim tried several different configurations of boosters and rectifiers. This poses a serious problem however, since the diodes (even schottkys) have threshold voltage that needs to be

reached. With our ever so small input signal, this was barely possible. After many attempts and a lot of testing, they decided to use an off-the-shelf booster designed to charge batteries or capacitors with very low input voltages.

### Sensing, Processing & Communication

The final part of the system is the one that does the measuring and makes the device an IoT device. As power consumption was the main concern, Ern  and I started by choosing a proper communication protocol. We also wanted a range in the order of about a kilometer. We ended up choosing for the LoRaWAN protocol which is very upcoming, specifically designed to be low power and has a range in the order of 15km.

We then had to decide on a microcontroller to process the information from the sensor and transmit it using the

LoRa transmitter. An Atmel ATtiny84a seemed a good option, it features I2C and SPI (needed for communication with the LoRa chip and the temperature sensor) and has good low-power capabilities such as very low sleep/stand-by currents.

### Results

After we designed all the subsystems and figured out how to interconnect them, we designed a PCB and had it manufactured. Of course we made some errors in the process, so we had to make some adjustments to get it to work. See figure 3 for the final result.

All the subsystems worked as planned and we were even able to charge, store, measure and send a packet – i.e. the whole cycle. However, this required quite some more RF energy than the normal ambient energy. In other words, we had a 900MHz function generator with an antenna right next to the device in order for it to work.

In conclusion, although our device wasn't efficient enough to really work with just ambient RF energy, we were in the right direction. We have shown that the concept works. With better design of the PCB, or even with integrated technology, the efficiency might be greatly improved to really achieve the goal. Time for further research!

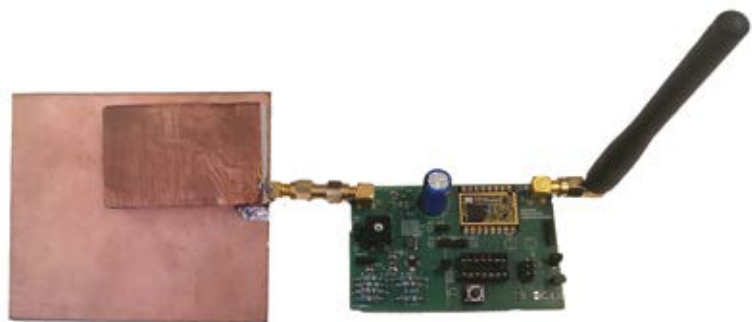

**Figure 3.** The PCB with the home-made antenna on the left side (for harvesting) and a transmitting antenna for LoRa on the right side.

# Professor of the Quarter

Richard Heusdens

Stefanie Brackenhoff  
Medha Subramanian

Every quarter the Maxwell Committee interviews a professor of the Quarter. This professor is chosen by asking Bachelor's students which professors of the upcoming quarters they like best. The professor of this quarter is Richard Heusdens.

Richard Heusdens is an associate professor at the Circuits and Systems group. His research interests include audio and acoustic signal processing, distributed signal processing, information theory and speech enhancement. Additionally, he teaches several Bachelor and Master courses and is Master coordinator of the track Signals and Systems. We went by to ask him about his field, his teaching and his life outside of the TU Delft.

## Why did you go into signal processing?

I love mathematics and signal processing is a form of applied mathematics to me. The difference is just that with signal processing, you can clearly see what you are doing it for.

## What is the most interesting thing you encountered during your career?

What I really like is the application of convex optimization in signal processing. It is a special branch of mathematics that works on convex functions. That means that these functions have a global minimum which can be found iteratively without any supervision. When a problem is convex, it is easy to solve. In the past, you had the difference between linear and non-linear problems to de-

## What topic would you like to focus your research on in the future?

For the last few years I have been working on distributed signal processing. That is signal processing in networks where you do not want to collect all data measured by sensors in one central location. You let the sensors do their own calculations and they only communicate with their local neighbours. A large class of problems can be solved without a centralized solution, completely asynchronous. I like that. It is useful in big data problems, for instance when you want to denoise an image using Google's databases. The company has datacenters all over the world, so you cannot copy all the data to locally search through it.

Distributed signal processing is not

it is usually more efficient. Nevertheless there are problems where you simply cannot do that.

## What are the most striking changes you have experienced in your field?

Signal processing is currently in the Signals & Systems group. In the past, we were housed at Information Theory, which is a computer science group. We were housed at this group, as we did a lot of data mining. However, being in a computer science group resulted in a lot of computer science students being attracted to us. Since we preferred electrical engineering students as they have more skills in mathematics, we decided to switch back to electrical engineering. At first, we mainly worked on data compression, which was very different from what was done in Signals & Systems. Later on, we started to work on speech enhancement. This entailed removing background noise, which is an estimation problem. That is also what the people in Signals & Systems were doing. Furthermore, we were using the same techniques as they were using. That is why we decided to join this group.

## If you could give one piece of advice to students, what would it be?

When you are in your Masters, choose the courses that you find interesting and try to be as broad as possible. Most students have the tendency to narrow

*"Distributed signal processing is not very nice from a control point of view, but for some problems it is necessary."*

scribe the meaning of easy and hard respectively, yet I would say in signal processing it is more fitting to use convex and non-convex. Many problems that are not convex at first sight can be reformulated into a convex problem. You can approximate a non-convex problem by a convex one to get an approximate solution.

very nice from a control point of view, but for some problems it is necessary. Think of situations such as in smart grids, forest fire detection and autonomous cars. Those problems are very ad hoc, so you cannot simply say "I don't care about communication costs, I'll just do it in a centralized way". Often that is fine; when a centralized solution works,

down to a certain topic, as they want to be specialists. I thought the same way when I was a student. Later, I realized that when working for a company, they will give you plenty of space to study the field that you have to work in. However, you never get to study another field anymore. Take a course in mathematics. It is not about the maths, it is about interpreting the equations. If you cannot look through the equations, there is no way you will understand the signal processing part. It is not the theory itself, it is the mathematics behind it that cause some students a lot of problems. Knowing your mathematics helps to visualize what's going on.

**What do you think is the most important skill for an electrical engineer to have?**

They should be good at modelling the problem they face. If you have a model, you can optimize. If you don't have a model, you can't solve the problem. Even if you have a bad model, at least you can optimize for that one and know that you have to improve the model to do better. If you do not know that, everything is shaky.

*"If you don't have a model, you can't solve the problem."*

**What are your other interests?**

I run and I train police dogs. That is a very time consuming hobby. The police buys dogs that are trained by special clubs. When we train protection dogs, I'm the guy who is wearing the protection suit that the dog bites at. It is very fun. I also have many dogs at home, I trained some. I don't sell them though. In the weekends I do construction work. I bought an old farmhouse from the 1880s and I am building stables for the horses. We have 6 horses, 5 dogs and 2 cats. It's a little zoo.



# Faculty Student Council

*Bram Dikker and Arian Joyandeh*

**The new academic year has been on it's way for some months now and the new Faculty Student Council (FSC) members are setting up shop. We even have a member abroad! Here is a short introduction on what the FSC is, does and how you could potentially join.**

## What is the FSC?

The FSC is a student representative council within our faculty EEMCS. In practice, the FSC works to improve the faculty on behalf of the students, by giving advice and participating in important meetings and discussions within the faculty. We have a weekly internal meeting to discuss problems that are present within the faculty. Furthermore, we discuss these problems with the board of EEMCS in a monthly meeting. We also attend the budget meetings within EEMCS, where we have a say in how the faculty spends its money. On top of that, we also discuss university-wide issues through meetings with the FSCs from other faculties, together with the Student Council of the university (including ORAS and Lijst Beta). The FSC has the right to advise, as well as the right of initiative regarding anything relevant to the students of EEMCS. This allows us to make a difference within the faculty!

## The elections

The FSC is chosen every year through elections. After the two election days, traditionally in May, the votes will be counted. Depending on the number of votes that have been cast, students can be appointed a seat in the FSC. Every student is allowed to sign up as a candidate for these elections, which makes the FSC a very diverse group. This can be witnessed this year as well: amongst our council, we have a freshman, master students and internationals. Since everyone that started this year is new to the council, we have a

fresh view on all faculty matters. Despite everyone being new, we have gotten off to a smooth start. Experiences that the council-members have gained in previous committees and councils are a great benefit to our daily work!

## The four chambers

Within the FSC, there are different "chambers", each representing a programme of study within EEMCS. There are 4 seats available in the Electrical Engineering chamber, 4 in the Computer Science chamber, 3 in the Mathematics chamber and 1 in the SET chamber.

This last chamber might sound a little new to students. SET is the abbreviation for Sustainable Energy Technology, a relatively new MSc programme that was initially part of the faculty of Applied Physics (TNW). Last year, they became part of our faculty, and thus also part of our FSC. Let us introduce ourselves among our chambers:

### Electrical Engineering chamber:

Erné Bronkhorst (Chairman)  
Joey van Rijn (Secretary)  
Thomas Roos  
Gabriele Zacca

### Computer Science chamber:

Bram Dikker  
Sterre Noorthoek (Treasurer)  
Francis Behnen  
Cas Buijs

### Mathematics chamber:

Arian Joyandeh  
Emiel Hoefkens  
Jorino van Rhijn

## Sustainable Energy Technology chamber:

Thomas Spruit (Secretary)

## What we are doing now

The new FSC is currently working in full speed. We have created various focus groups, in which we discuss matters such as the current capacity of the building, sustainability and internationalization. We have had a university-wide training together with all the other FSCs, where we have already learned a lot. Furthermore, we have had our first FO, where we met with the other FSCs to discuss current issues that apply to all faculties. One important topic for instance, is the improvement of Collegerama. During our mandate, we will make EEMCS great again!

## We want your input!

We are always gathering input on subjects that need improvement this year. For that, we also need your help.

Every quarter, we will organize a coffee moment to talk to students and conduct a survey. You can then find us in the hall of EEMCS with free coffee and cookies, ready to hear your stories about studying at EEMCS. We would be pleased to hear about all the problems you encounter throughout the faculty, as well as any ideas you might have for improving the education at EEMCS. If you do not want to wait until the next coffee moment, you can always send us an email at [fsr@ewi.tudelft.nl](mailto:fsr@ewi.tudelft.nl)!



# Specialist in Power Quality

Optimizing electrical installation efficiency, reliability and safety

**HyTEPS offers an ideal environment to gain practical experience in the field of our expertise: Power Quality.**

Working at HyTEPS means working on various and challenging projects in diverse sectors such as: healthcare, industry, maritime and utility. Most of our projects are performed on customers site, mainly situated in The Netherlands. Our electrical engineers are responsible for researching, analyzing and solving complex problems within all kinds of electrical installations.

*Working at HyTEPS is not just a job  
it is an unforgettable experience*

## What can you expect

- Receive extensive (on the job) training from our skilled engineers
- Perform measurements at various points in the installation
- Make use of specialized equipment
- Analyze obtained (measurement) data and interpret results
- Write technical measurement and advice reports
- Perform commissioning of installed HyTEPS equipment
- Work in a wide variety of sectors
- Team up with smart and sociable colleagues

Do you want to take on a challenging role at HyTEPS? Visit our website for more information: [www.hyteps.nl/over-hyteps/werken-bij](http://www.hyteps.nl/over-hyteps/werken-bij)

# Life on Halfgeleiderweg

## Column: a peek into the world of Electrical Engineering students

Sagar Patel

**In this year's Maxwell, each edition will feature a column in which an Electrical Engineering student will tell about his or her experiences. This quarter, master student Sagar Patel, from the Power-track, will shed some light on his daily student life. He chose to use his 15 ECTS of free electives to do an internship. He went to NXP Semiconductors in Nijmegen to get more acquainted with the Dutch working culture as well as with the company itself.**

NXP Semiconductors, formerly known as Philips Semiconductors, became a separate company in 2006. NXP is an abbreviation for Next eXPerience. While its head-quarters are located in Eindhoven, NXP has the largest chip-manufacturing plant of Europe located in Nijmegen.

During the internship, I spent my time at the department of Smart Interface and Power within NXP Nijmegen. As part of the assignment, I had to select some commercially-available power supplies for industrial automation from various manufacturers and test them for their performance (i.e. efficiency, power factor, harmonics). After the testing had been completed, I had to open up the power supplies and reverse-engineer them. This had to result in the construction of a circuit diagram, so that I could understand which type of

topology is being used and how it is operated at different conditions. During this process, I felt like Sherlock Holmes (of Power Supplies).

Nijmegen itself is a beautiful city, as well as the oldest Dutch city. Situated

*"During this process, I felt like Sherlock Holmes."*

on the banks of the Waal (a branch of the Rhine), it was originally founded as a Roman military camp. Geographically, it is different from a typical Dutch city. It has its own "hill" in the city centre, which is home to some of the Roman ruins.

The experience of living in Nijmegen was very pleasant. As a student of Electrical Sustainable Energy, I was happy to know that the city is the European Green Capital of 2018 for their efforts towards sustainability. Furthermore,

living-costs in Nijmegen were significantly lower than in Delft for an international student. However, the usual problem of finding a house in a Dutch city without speaking Dutch, is still there.

My favourite outdoor activity was visiting the close-by German town of Kranenburg by bike. Now I can proudly say that I have crossed borders on a bike! Besides biking, the people of Nijmegen enjoy walking. The city's most famous event is not even King's Day - it is the Four Days March in July. People from all over the world come to Nijmegen to walk around the city. The city is turned into a single carnival with many food-stalls and activities besides the walking.

As Nijmegen is also a university city, there are plenty of activities for students. The ESN chapter of Nijmegen was very active, which helped me find many new friends in a completely new city. The Young NXP group is also active in connecting young employees by organizing various events. Furthermore, I was able to do activities that cannot be done during coursework, including volunteering. I volunteered at several events through the Young NXP group and other organizations.

All in all, I am very happy that I did an internship at NXP. Because of it, I moved out of my comfort zone and opened up many new possibilities for myself.



# A Klushok-project

## Touch sensors

Tom Salden

The DIY-Room, also called the “Klushok”, is a unique room within the faculty of EEMCS that can be located by following the signs starting at the main entrance, or by searching for the door across the ETV Board room. To enter, just ask any of the board members, they will open the door for you and explain anything you need to know! Inside the room, you will find all sorts of tools and measuring devices, to aid you in every electronics project you could imagine. Furthermore, there are cabinets filled with various components you can use. Opposite from the oscilloscopes, function generators and power supplies, you will find a mechanical workbench equipped with the basic tools you need to construct your own enclosures. To help you get started, we included this project:

### Touch sensors

As technology progresses, new inventions are constantly being made. Every new product is better than the previous one and will usually be more expensive and more complicated. However, not all fancy ideas need extremely complex products. A touch sensor is one of these examples. Touch sensors can be used to integrate electronics. Instead of using a big switch or button, a mere touch on a copper plate is enough.

There are two examples of touch sensors, which can only control an LED on their own. However, these circuits can be connected to form a microcontroller, like an Arduino, to make them do more interesting things. In addition, a relay can be used to control appliances without the microcontroller.

### Touch sensor instead of a button

Instead of a simple button that is only powering a circuit when you press it, the following little circuit can be built. The circuit is powered by an LM358 dual op-amp. In Figure 1, the schematic is shown. In order to connect this circuit to an Arduino or a similar microcontroller, connect VCC to a 5V supply and use the output of pin 1 (OUT1) for the Arduino. The LED and its resistor can now be omitted. For the touch plate, a copper clad can be used. Solder a wire to it and connect it to pin 3.

### Touch sensor instead of a switch

A different implementation of a touch sensor is found by making the circuit save its last state. This way, the circuit effectively acts as a switch that can be turned on or off. The main component here is a 555-timer that is used as a comparator. Figure 1 shows the circuit of this implementation.

If this circuit is to be connected to an Arduino, use the output of pin 3 (Q). Again, the LED and resistor can be omitted for this usage. As can be seen in the schematics, two copper plates need to

be placed close to each other. To achieve this, you can simply use a copper side of a copper clad board. Now, a narrow and deep cut needs to be made on the copper side, isolating the two parts without breaking the board. Once this is done, solder a wire to each of the two sides. Now you're finished!

We hope to see you soon!

*The Klushok Committee*

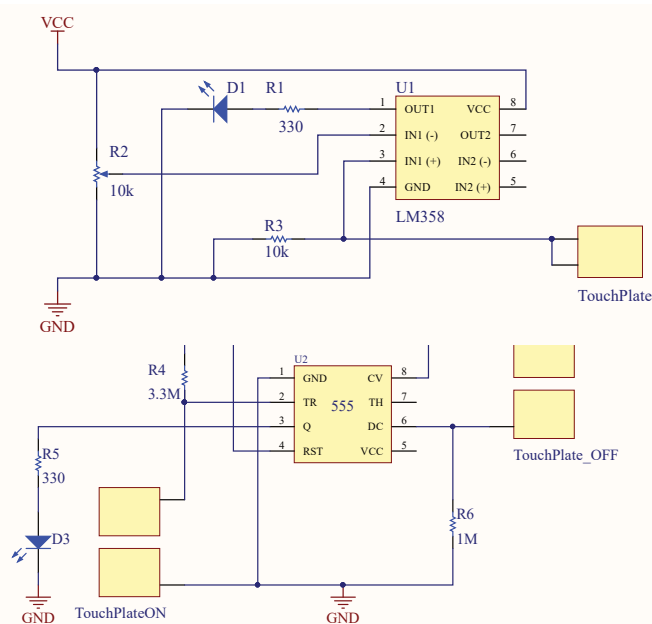

Figure 1. Touch button (top figure) and touch switch (bottom figure)

# Activities

## An overview of last quarter's events

### Freshmen's Weekend (EOW)

Becoming a student is not an easy task, as it is so much more than just studying. Making new friends, discovering the university and meeting other students are just some of the things that cannot be taught in a lecture. That is why the ETV annually organises the "Electro Ontvangst Weekend" (EOW) for all future Electrical Engineering students. This year, the EOW was as great a success as always. The first day focused on the faculty, while the rest of the weekend was about meeting fellow students at a nearby campsite. On the camp location, a lot of fun activities were organised, such as a bbq, a day at the beach and an epic party with "De Broer van Henk", to make sure everybody had a good time! The weekend was a great start for the freshmen, for studying electrical engineering as well as enjoying everything the student life has to offer.

*Joos Vrijdag*

### Welcome Back BBQ

On a beautiful sunny evening in September, a big number of ETV members came together after a long summer break. The zAkCie (Summer Activities Committee) had the honour of grilling plenty of tasty meat for the hungriest tigers of the ETV, on the annual and highly-beloved event called Welcome Back BBQ.

After a long day of studying, the famous piano tap provided everyone with a good deal of golden pints. Just outside of EEMCS was the perfect location to sit in the sun and to be pleased with all the good things summer offers you. It was the ultimate chance to exchange the most tasteful stories about the wonderful summer and the amazing EOW. As the sun went down and fell beneath the horizon, the barbecue turned into an evening to remember.

*Rik Bokhorst*

### Interfaculty Party (IFF)

We can certainly include the Lorre in the list of the most interesting night clubs of Delft. Freshmen get a good chance to fully experience this basement of the Phoenix during the annual Inter Faculty Party (IFF).

This year's edition had an extra dimension, as the disco had been renovated over the summer. The whole floorplan has been changed, and it actually looks kind of chic now!

Many older students used this opportunity to check for themselves whether the infamous smell had really left the club. Even the ladies of Corpus Delicti came by, resulting in a mixed audience to kick off the party season perfectly!

*Tijs Moree*





### Kwartjes Evening

On the 9th of October, many members of the ETV gathered at the /Pub for the last activity of the EOW-Committee: Kwartjesavond! On this evening, the participants reunited after the Freshmen's Weekend (EOW) of last August.

The long-expected poster with this year's freshmen was revealed and handed out to all. Also, the photos taken at the EOW were shown, to remind all who were there of how epic this year's weekend was.

Last but not least, the participants of the Kwartjesavond had the chance to spend the remainder of their EOW-coins on the (very cheap) drinks! It was the perfect evening to close the list of activities of the EOW-committee. We hope everyone enjoyed it!

One Kiss on behalf of the 36th EOW-Committee.

*Michael Goddijn*

### A freshman's impression

Always tired, actually doing homework and studying for the midterms at the end of the first five weeks. It is a whole other world than high school, and very different from nearly three months of summer break!

Of course, this difference is not a surprise. There have been plenty of warnings that studying is not a 24/7 party, but that hard work is needed to get through the first year.

Even though you have to work more than 40 hours a week, there are some bright moments. Studying with friends while making jokes is something we do on a daily basis. In addition, we can go to the gatherings of the ETV where we catch up with all our fellow students. So, even though the beginning is tough, it is quite enjoyable once you combine studying with relaxing and having fun!

*Floor Walterbos*





## New Electrical Sustainable Powerlab smooths the way for energy transition

A new laboratory, the only one of its kind in the world, is being built in Delft. The **Electrical Sustainable Powerlab** will bring together scientists researching the generation, transfer, distribution and use of electricity by households and companies. The aim is to ensure a smooth transition to more sustainable energy. *“The new laboratory will make it possible to test how everything connected to the electricity grid will react to it”.*

*Miro Zeman*

*TU Delft Professor of Photovoltaic Materials and Devices*

**Read more on: [tudelft.nl/en/eemcs/current/nodes](https://tudelft.nl/en/eemcs/current/nodes)**

# Upcoming activities

For members of the Electrotechnische Vereeniging

*Lotte Zwart*



## Lunch Lectures

This quarter there will be a lot of lunch lectures again. Of course there will be delicious sandwiches from Leo!

To attend these lectures you need to subscribe to the Facebook event posted on the ETV Business page. Keep a close eye, because new ones are posted every week!

**When:** To be determined

**Location:** Lecture halls

**Price:** Free!



## Discussion evening

The general assembly in its current form is a long standing tradition. However, some aspects could be changed to make it more interesting to attend it. Therefore the 147<sup>th</sup> board presents the Discussion Evening, here you can give your opinion on the new proposal!

**When:** Tuesday the 20<sup>th</sup> of November

**Location:** Snijderzaal

**Price:** Free!



## Sinterklaas & Christmas Lunch

The holidays are almost upon us! To celebrate this you can join us for a Sinterklaas lunch. Before the lunch you can build your own shoe, in which you can receive all kinds of goodies from different companies at the lunch!

At the last lecture day Santa Claus will join us for a Christmas story and Glüh-wine to celebrate.

**When:** 4<sup>th</sup> & 21<sup>st</sup> of December

**Location:** \Pub

**Price:** €2 for Sint & €3 for Christmas



## Weekend away

The Weekend Committee has started off with some good ideas about a wintery weekend away. The ideas aren't yet set in stone, but it's going to be an awesome weekend for sure! Registration for this trip will open around week 2.4.

**When:** 12&13 January

**Location:** To be determined

**Price:** To be determined



## LaTeX workshop

Have you ever heard of LaTeX? Chances are you haven't if you've just started this year. LaTeX is a text editing language used in the academia from EPO-1 up until your master thesis.

To learn more about what LaTeX is and how you can use this, you can come to the workshop. Here you will get hands-on experience with LaTeX.

**When:** 22<sup>nd</sup> of November 8:30-12:00

**Location:** DW-Tentamenzaal 1

**Price:** Free!



## Wintersport

This year's wintersport will lead a select group ETV members to the beautiful slopes of Bardonecchia in Italy. In the third Maxwell we will hear all about the adventures to come!

**When:** From 2 to 10 February

**Location:** Bardonecchia, Italy

**Price:** €339

SWL35 T LU

PAD EYE  
BD 124  
SWL 40 TON

**surgical precision**

***Ilseas***